



mta

SOLDERING & DISPENSING

# Volumetric dispensing Solutions

---

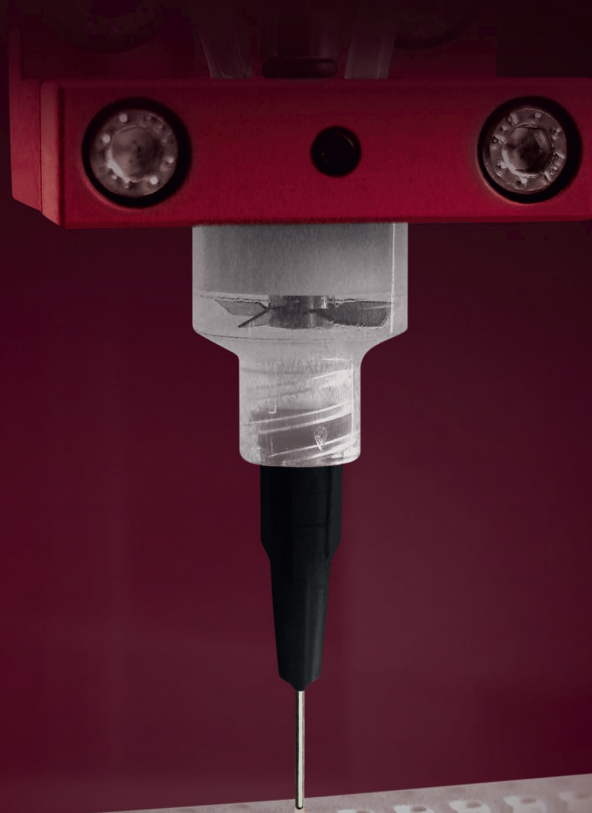

unitechnologies

THE ART OF PRECISION

---

# Summary

<b>From concept to turnkey solutions .....</b>	<b>p 3</b>
<b>Services &amp; support .....</b>	<b>p 3</b>
<b>Volumetric dispensing .....</b>	<b>p 4</b>
Examples of applications.....	p 4
<b>Pump working principles .....</b>	<b>p 5</b>
<b>Continuous flow dispensing.....</b>	<b>p 5</b>
<b>Jet dispensing.....</b>	<b>p 5</b>
<b>Dispensing techniques.....</b>	<b>p 6-8</b>
Numerical dispensers.....	p 6
Jet dispenser .....	p 6
Continuous flow dispensers.....	p 7
Cartridge dispenser.....	p 7
Mini numerical dispensers .....	p 8
Mini numerical dispenser controller .....	p 8
<b>Standard platforms.....</b>	<b>p 9-15</b>
MRC500 robotic cell.....	p 9
TR300 table-top robot .....	p 10
OEM robot for integrator .....	p 11
Station for integrator.....	p 12
MultiFlex® multidispensing system.....	p 13
Integration of material processing system .....	p 14
Examples of applications.....	p 15
<b>Dispensing configurator.....</b>	<b>p 16-17</b>
<b>Platform controllers.....</b>	<b>p 18</b>
Robotic cell and table-top robot.....	p 18
OEM and station for integrator.....	p 18
<b>mta® software .....</b>	<b>p 19</b>
mta® software .....	p 19
Software comparison .....	p 19
<b>Providing turnkey solutions .....</b>	<b>p 20</b>
<b>Assembly line example .....</b>	<b>p 20</b>
<b>Key competences.....</b>	<b>p 21</b>
<b>Dispensing consumables.....</b>	<b>p 22-23</b>
Piston/cylinder pumps .....	p 22
Mixing chambers.....	p 23
Dispensing nozzles .....	p 23
Cleaning sponges .....	p 23



mta

SOLDERING & DISPENSING

## From concept to turnkey solutions

Unitechnologies SA, with its mta® brand, is an expert in small quantity volumetric dispensing processes based on standardized platforms. The product range includes components, standalone systems, semi-automatic table-top robots and entirely automatic production cells or lines.

Thanks to a complete infrastructure, trials can be carried out on samples using all proven mta® dispensing techniques in the company's test laboratories.

Once the mta® technique has been validated, a detailed quotation is established with the proposed standard machine adapted to the customer's specifications.

For the peripheral automation processes of the dispensing operations, turnkey automated lines are also offered.

Unitechnologies mechanical and software engineers, designers and technicians provide on-site installation and training to customers as well as worldwide after-sales services.



## Services & support

### Test laboratories

During the feasibility studies in the dispensing laboratory, the physical properties of the applications and other elements are studied down to the smallest detail. Based on this analysis, the most appropriate mta® dispensing techniques can be defined for each specific application and a detailed report confirming the feasibility and the characteristics can be established.

### Process & innovation

mta® process specialists constantly work to develop innovative products and services in-line with the market's development and the specific needs of customers.

### Customer services

The Unitechnologies' customer services can provide advice, remote or onsite intervention with speed and reliability. With a large range of spare parts in stock, the customer's system will stay at the cutting edge of technology.

### Worldwide presence

As a partner to numerous companies in industries such as automotive, electronics, medical, watchmaking, telecom and household appliances, Unitechnologies has an international sales and distribution network dedicated to advice, sales and customer support.

### Swiss quality

More than 3'500 mta® systems produced and installed throughout the world meet the customer's expectations in terms of quality thanks to "Swiss made" criteria and to a rigorous application of a certified ISO 9001 quality management system.



## Volumetric dispensing

The mta<sup>®</sup> high-precision volumetric dispensers offer the most accurate volume control available in the fluid dispensing industry. They enable perfect repeatability of micro-volumes to be dispensed starting with 0.1 mm<sup>3</sup>.

The pumping unit maintains accuracy in the most demanding of circumstances independently from changes of temperature, viscosity or deposit size. The mta<sup>®</sup> dispensers are based on a piston that moves within the dispensing chamber to deliver an exact quantity of fluid through the nozzle. The working principle is described on page 5.

Before choosing the most appropriate dispensing technique, the customer's application is studied in the mta<sup>®</sup> test laboratory. During these feasibility studies, properties such as specific density of material to be dispensed, mixing ratio and viscosity are analyzed.

By using mta<sup>®</sup> techniques such as volumetric dispensing for two-component or mono-component products, standardized automated solutions are proposed for all the customer's specific applications. These techniques are detailed on pages 6, 7 and 8.

The dispensers can be integrated into the various mta<sup>®</sup> standard platforms, adapted for fully automatic or semi-automatic operations, such as the MRC500 robotic cell, the TR300 table-top robot, the OEM robot or the station. The dispensing platforms are detailed on pages 9 to 14.

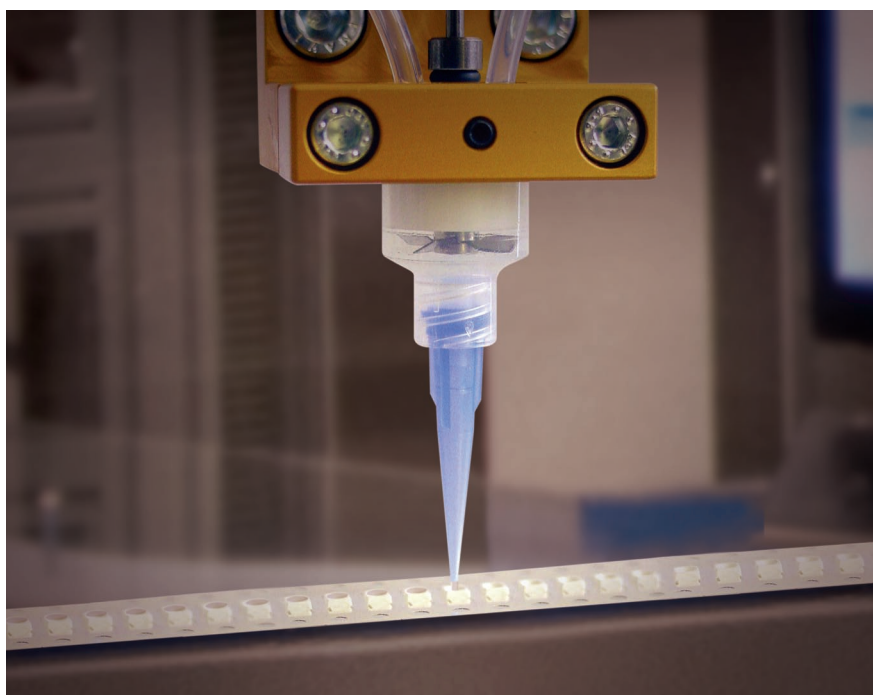

## Examples of applications

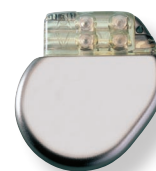

Deposit of mono-component silicone adhesive on a pacemaker



Dispensing of two-component epoxy on optical fiber connector



Filling of two-component silicone into electronic connector



Grease dispensing on drill bits for machining



Filling of two-component polyurethane into rotary pump (medical)

## Pump working principles

The basic working principles of the pump combines a linear movement to define the quantity of material to be dispensed (see 2 and 4 in the picture on the right) and a rotating movement (see 3 in the picture) to transfer the material from the pump input to its output.

The accurate pump assembly can be divided into different leak rates in order to be perfectly adapted to different types of material characteristics. This solution is highly precise and always volumetric.

Picture legends: 1. Home position, 2. Filling stroke, 3. Rotation, 4. Dispensing stroke and snuff back.

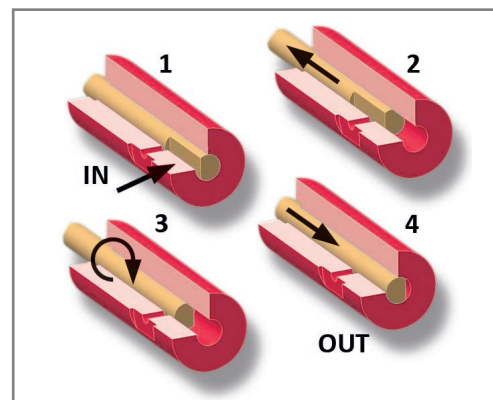

## Continuous flow dispensing

The constant flow rate is achieved through progressive cavity pump and involves the eccentric rotary motion of a stainless steel helical rotor into an elastomer stator. Due to their precise and complementary geometries, the rotation of the rotor in the stator generates fixed-size sealed cavities which are continuously conveyed forward up to the discharge end. The suction resulting from this movement pulls the fluid into the sealed cavities towards the dispensing nozzle. The volumetric flow rate is therefore proportional to the angular speed of the rotor and is controlled with a high degree of accuracy.

Due to the rounded geometry of the cavities, low shear rates are applied to the dispensing fluid, thus allowing to dispense shear sensitive, thixotrope and high-viscous materials.

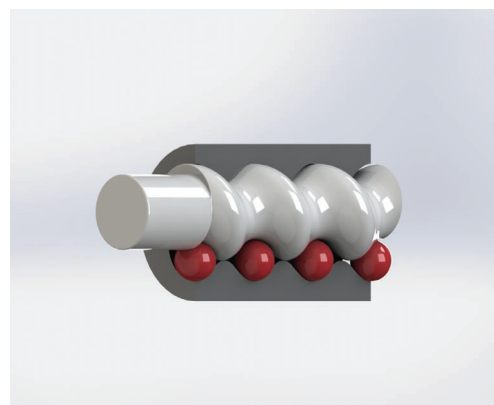

## Jet dispensing

With the growing demands of miniaturization and cycle time reduction, the jetting offers faster speed, high precision and more flexibility in terms of accessibility and trajectories. This contactless dispensing technique uses pneumatic or piezoelectric actuated valves to propel droplet of fluids out of the nozzle which results in dots of small size and volume.

As there is no contact with the surface and no necessity of a needle, the fluid can be dispensed into tight spaces along any trajectory such as thin lines, sharp corners, etc. However the major asset of propelling small dots from above the working surface is that no Z-motion is required, thereby significantly increasing speed and reducing cycle time.

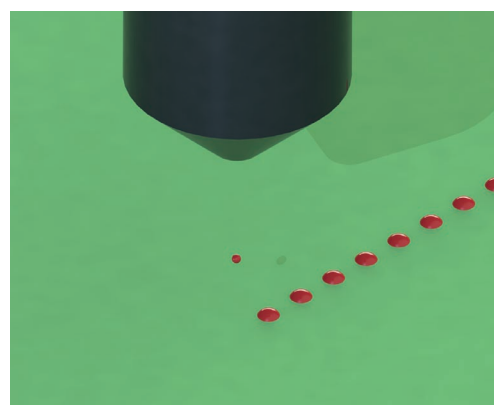



# Dispensing techniques

## Numerical dispensers

- Automatic volumetric dispensing of mono-component (NVD) and two-component (NBD) liquid or viscous products down to small volumes
- Intended for gluing, potting, coating and greasing processes
- Simple setting of dispensing parameters via numerical controller
- Piston and cylinder made of ceramic
- No seals in the piston-cylinder system
- Material pre-heating possible

\*mta® mixing device for the NBD two-component dispenser:

- Mixing by dynamic or static mixer
- Low-volume dynamic mixing chamber
- Programmable mixing ratio

NVD 1K



NBD 2K



Technical specifications	NVD	NBD
Dispenser volume per stroke	0.1 to 1'250 mm <sup>3</sup>	2 x 0.1 to 1'250 mm <sup>3</sup>
Repeatability	>99%	>99%
Power supply controller	230V/50-60Hz	230V/50-60Hz
Air pressure	max. 6 bar	max. 6 bar
Dispenser dimensions	93 x 117.5 x 386 mm	254 x 129.5 x 375.5 mm
Dispenser weight	~3.5 kg	~8.5 kg

*\*applicable to the Mini-NBD and CBD*

## Jet dispenser

- High frequency dispensing of low volume droplets with low and high viscosity products
- Advantageous cycle time as no vertical motion is needed
- Capacity to dispense into tight spaces with all shape trajectories
- No contact to the working surface and no needle - low maintenance
- Simple setting of the dispensing parameters via numerical controller such as drop size, pulse time, etc.
- Heating of the valve seat to ensure high degree of repeatability of the drop volume

Jet dispenser

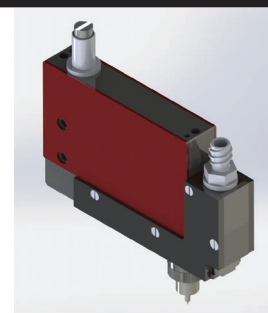

Technical specifications	
Typical volume per drops	0.002 to 5 mm <sup>3</sup>
Dispensing drop quantity*	max. 330 per second
Nozzle heating temperature*	max. 100°C
Repeatability	>97%
Power supply controller	230V/50-60Hz
Air pressure	max. 6 bar
Dispenser dimensions*	22 x 90 x 160 mm
Dispenser weight	<0.5 kg <i>*other possibilities upon request</i>



mta

SOLDERING & DISPENSING

## Dispensing techniques

### Continuous flow dispensers

- Automatic or manual dispensing of mono-component (CFD) and two-component (CBD) liquid or viscous products including loaded material
- Volumetric continuous flow dispensing thanks to a rotating displacement system
- Simple setting of the dispensing parameters via numerical controller
- Material pre-heating possible

CFD 1K



CBD 2K



Technical specifications	CFD	CBD
Dispenser volume	minimum 1 mm <sup>3</sup>	minimum 2x 1 mm <sup>3</sup>
Disp. volume per revolution	12 to 530 mm <sup>3</sup> **	2x 12 to 530 mm <sup>3</sup>
Flow rate*	2 to 1'000 mm <sup>3</sup> /s**	2x 2 to 1'000 mm <sup>3</sup> /s
Repeatability	>99%	>99%
Power supply controller	230V/50-60Hz	230V/50-60Hz
Air pressure	max. 6 bar	max. 6 bar
Dispenser dimensions	43 x 33 x 230 mm	150 x 77.5 x 420 mm
Dispenser weight	~0.8 kg	~3.5 kg

\*depending on dispensing material

\*\*larger choice upon request (up to 4'500 mm<sup>3</sup>/s)

### Cartridge dispenser

- Automatic volumetric dispensing of mono-component liquid or viscous products including loaded material
- Simple setting of the dispensing parameters via numerical controller
- Compared to time-pressure systems, the CD dispenser offers higher precision achieved via the stepper motor and no further customization is necessary thanks to standard cartridge type
- Simple handling and changeover by unclipping/clipping the cartridge
- No cleaning of the dispenser cartridges thanks to the zero-contact design
- Material pre-heating possible

CD



Technical specifications	
Possible cartridge size	3, 5, 10 and 30 cm <sup>3</sup>
Standard cartridge type	EFD or SEMCO (other types optional)
Repeatability	95% as per material and volume to be dispensed
Power supply controller	230V/50-60Hz
Air pressure	max. 6 bar
Dispenser dimensions	62 x 61 x 333 mm
Dispenser weight	~1.6 kg

# Dispensing techniques

## Mini numerical dispensers

- Automatic volumetric dispensing of mono-component (Mini-NVD) and two-component (Mini-NBD) liquid or viscous products down to very small volumes
- Simple setting of the dispensing parameters via numerical controller
- Compact design allowing the use of Mini-NVD as series with the desired quantity (multidispensing)
- Both motor control card and pneumatic valve are integrated into each single Mini-NVD providing individual plug and play system
- Piston and cylinder made of ceramic
- No seals in the piston-cylinder system
- Material pre-heating possible

Technical specifications	Mini-NVD	Mini-NBD
<b>Dispenser volume</b>	0.1 to 160 mm <sup>3</sup>	2 x 0.1 to 160 mm <sup>3</sup>
<b>Repeatability</b>	>99%	>99%
<b>Power supply controller</b>	230V/50-60Hz	230V/50-60Hz
<b>Air pressure</b>	max. 6 bar	max. 6 bar
<b>Dispenser dimensions</b>	32.5 x 270.5 x 116 mm	122 x 275 x 220 mm
<b>Dispenser weight</b>	~1 kg	~3 kg

Mini-NVD 1K

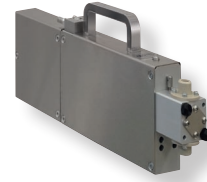

Mini-NBD 2K

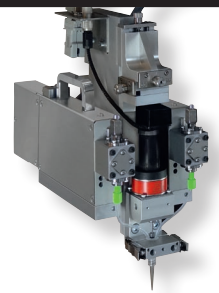

## Mini numerical dispenser controller

The Mini-NVD implements its own intelligent servo drive with embedded motion controller and PLC functionality. It can perform standalone operations, using the stored motion sequences and can be easily integrated into a machine with a simple PLC communication. A common start can thus drive several Mini-NVDs with specific recipes. The creation and the modification of the recipes stored in the dispensers are carried out remotely and individually. The operator selects the Mini-NVD to be set and creates or modifies the recipe along with all its process parameters.

The management of the system is very easy and intuitive. All the required functions are already implemented in order to allow a quick start-up of the dispenser.

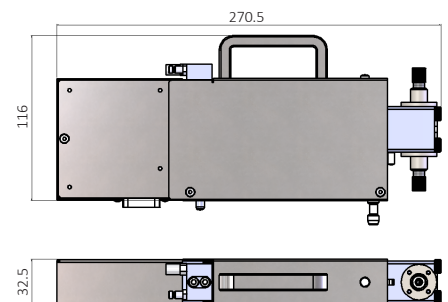





mta

SOLDERING & DISPENSING

## Standard platforms

### MRC500 robotic cell

The PC controlled MRC500 standard robotic cell can be used for semi or fully automatic operations of volumetric dispensing operations.

The MRC500 can be equipped with all the established mta® dispensing techniques described on the previous pages.

The 3 axes of the MRC500 are fully programmable through the mta® MotionEditor software including dispensing parameters such as:

- Volume to be dispensed, dispensing speed, mixing ratio as well as other related dispensing parameters e.g. unlimited quantity of points, linear or circular beads.

Thanks to its flexible and modular concept, the MRC500 has an open architecture and can easily be integrated into existing production lines with pallet conveyors or a rotary table.

The MRC500 robotic cell provides standardized automation solutions with the highest quality and repeatability for all customer's specific applications.



#### Technical specifications

<b>Working area</b>	500 x 500 x 200 mm or 300 x 300 x 200 mm (MRC300)
<b>Cartesian robot</b>	3 axes
<b>Shift of axes</b>	point by point or linear interpolation
<b>Positioning repeatability</b>	±20 µm
<b>Speed</b>	X and Y: <300mm/s, Z <150mm/s
<b>Electronic control</b>	industrial PC
<b>Operating system</b>	WINDOWS
<b>Programming</b>	HMI Windows oriented
<b>Interfaces</b>	Ethernet / USB port / Serial port
<b>Execution mode</b>	standalone or slave with PLC via I/O interface
<b>X, Y and Z axes actuation</b>	Servomotors
<b>Power supply</b>	400/208V- 50/60Hz
<b>Power consumption</b>	1 kVA
<b>Air pressure</b>	max. 6 bar
<b>Dimensions</b>	1'425 x 1'420 x 2'250 mm
<b>Weight</b>	~650 kg

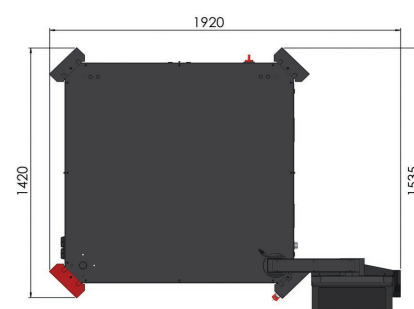
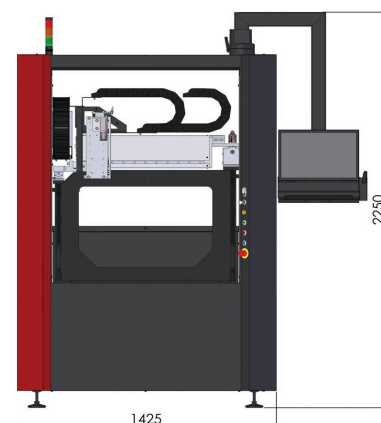

## Standard platforms

### TR300 table-top robot

The PC controlled TR300 standard table-top robot can be used for semi-automatic operations of volumetric dispensing operations.

The increasing requirements for processes in terms of quality, precision and repeatability lead to a similar increase in the necessary level of automation. However, when production batches are small or products widely dissimilar, the cost of sophisticated equipment can place automation beyond the reach of many would-be users. The TR300 combines the necessary flexibility with the required high levels of process quality and repeatability, all at reasonable cost.

The TR300 can be equipped with all the established mta® dispensing techniques described on the previous pages.

The 3 axes of the TR300 are fully programmable through the mta® MotionEditor software including dispensing parameters such as:

- Volume to be dispensed, dispensing speed, mixing ratio as well as other related dispensing parameters e.g. unlimited quantity of points, linear or circular beads.



#### Technical specifications

<b>Working area</b>	300 x 300 x 100 mm
<b>Cartesian robot</b>	3 axes
<b>Shift of axes</b>	point by point or linear interpolation
<b>Positioning repeatability</b>	±20 µm
<b>Speed</b>	X and Y: <200mm/s, Z <100mm/s
<b>Electronic control</b>	industrial PC
<b>Operating system</b>	WINDOWS
<b>Programming</b>	HMI Windows oriented
<b>Interfaces</b>	Ethernet / USB port / Serial port
<b>Execution mode</b>	standalone or slave with PLC via I/O interface
<b>X, Y and Z axes actuation</b>	stepper motor
<b>Power supply</b>	230/115V- 50/60Hz
<b>Power consumption</b>	1 kVA
<b>Air pressure</b>	max. 6 bar
<b>Dimensions</b>	804 x 732 x 995 mm
<b>Weight</b>	~125 kg

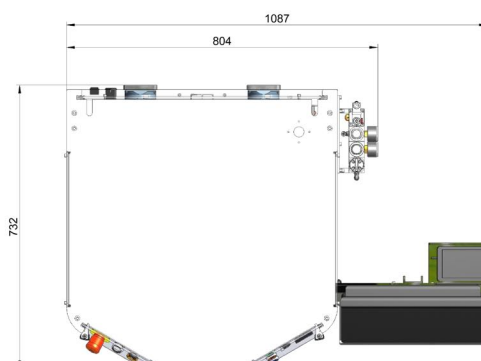
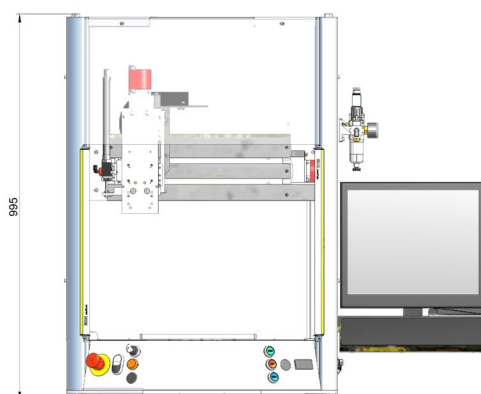



mta

SOLDERING & DISPENSING

## Standard platforms

### OEM robot for integrator

The PC controlled OEM standard robot can be used for semi or fully automatic operations of volumetric dispensing operations.

Thanks to its unique concept, the OEM robot is delivered to the system's manufacturer with a process guarantee.

The OEM robot can be equipped with all the established mta® dispensing techniques.

The 3 axes of the OEM robot are fully programmable through the mta® Motion-Editor software including dispensing parameters such as:

- Volume to be dispensed, dispensing speed, mixing ratio as well as other related dispensing parameters e.g. unlimited quantity of points, linear or circular beads.

With its flexible and modular concept, the OEM robot can be fully and easily integrated into a production line (no safety guarding included).

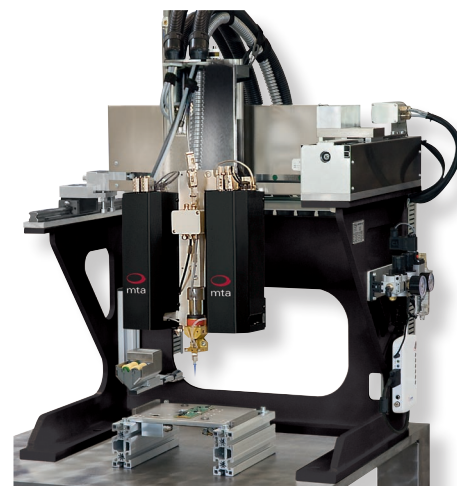

#### Technical specifications

<b>Working area</b>	300 x 300 x 200 mm or 500 x 500 x 200 mm
<b>Cartesian robot</b>	3 axes
<b>Shift of axes</b>	point by point or linear interpolation
<b>Positioning repeatability</b>	±20 µm
<b>Speed</b>	X and Y: <250mm/s, Z <150mm/s
<b>Electronic control</b>	industrial PC
<b>Operating system</b>	WINDOWS
<b>Programming</b>	HMI Windows oriented
<b>Interfaces</b>	Ethernet / USB port / Serial port
<b>Execution mode</b>	standalone or slave with PLC via I/O interface
<b>X, Y and Z axes actuation</b>	DC Brushless motors
<b>Power supply</b>	230/115V- 50/60Hz
<b>Power consumption</b>	1.1 kVA
<b>Air pressure</b>	max. 6 bar
<b>Dimensions</b>	756 x 585 x 933 mm
<b>Weight</b>	~150 kg

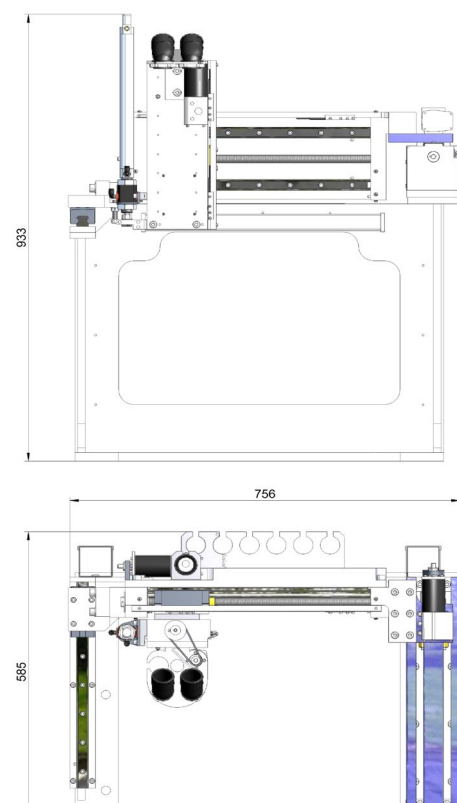

## Standard platforms

### Station for integrator

For applications that do not require the flexibility of a robot, a simple station is available for semi or fully automatic operations of volumetric dispensing.

The modularity of slides and standard elements enable to find a solution adapted to the customer's application.

The station can be equipped with all the established mta® dispensing techniques.

Thanks to its modular concept, the station can be integrated into a line or onto a rotary table (no safety guarding included).



#### Technical specifications

<b>Work area</b>	according to the customer's needs
<b>Axes</b>	pneumatic
<b>Controller</b>	mta® controller available upon request
<b>Interfaces</b>	via I/O
<b>Power supply</b>	without controller 24VDC
<b>Power supply</b>	with mta® controller: 230/115V- 50/60Hz
<b>Power consumption</b>	1.1 kVA
<b>Air pressure</b>	max. 6 bar
<b>Dimensions</b>	from 250 x 250 x 540 mm to specific dimensions
<b>Weight</b>	variable from 50 kg to 100 kg

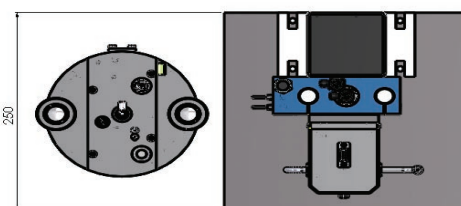
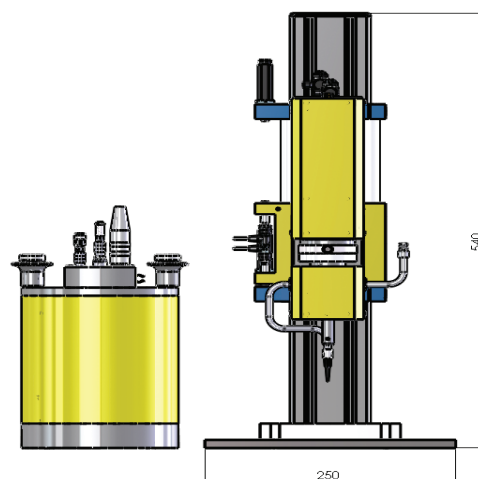



mta

SOLDERING & DISPENSING

## Standard platforms

### MultiFlex® multidispensing system

The MultiFlex® system has been designed for volumetric, high precision multi-dispensing of small product quantities for applications mainly in the medical, pharma, food or packaging industries.

The MultiFlex® is a very compact solution to answer the multidispensing needs. The MultiFlex® consists of a series of mta® Mini-NVD mono-component dispensers which can be controlled independently.

Each Mini-NVD dispenser is equipped with its own electrical controller and can be set with specific dispensing parameters. This smart solution has many advantages, especially in terms of maintenance. In addition, thanks to the «Plug and Play» system, the changeover of the dispenser is carried out in no time.

The MultiFlex® system configuration is adapted to the customer's requirements with up to several hundred units working in parallel.

### Example of a MultiFlex® with 32 Mini-NVD

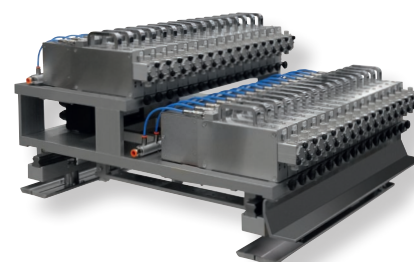

Technical specifications	For 1 Mini-NVD	For 32 Mini-NVD*
Dispenser volume per stroke	0.1 to 160 mm <sup>3</sup>	32 x 0.1 to 160 mm <sup>3</sup>
Repeatability	>99%	>99%
Power supply controller	230V/50-60Hz	230V/50-60Hz
Air pressure	max. 6 bar	max. 6 bar
Dimensions	32.5 x 270.5 x 116 mm	610 x 630 x 433 mm
Weight	~1 kg	~50 kg

\*see example on the right

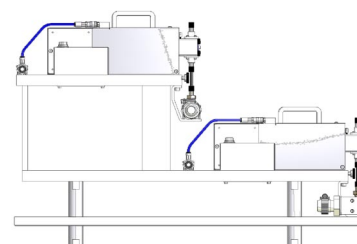
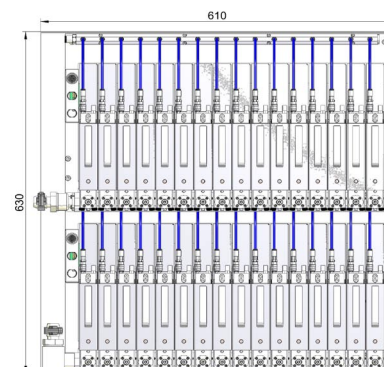
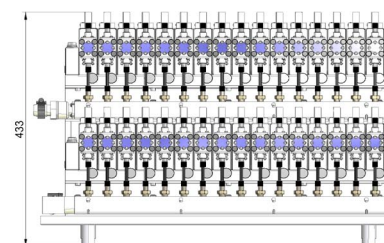



## Standard platforms

### Integration of material processing system

For the liquid handling and its preparation, Unitechnologies offers the integration of custom-designed emptying, feeding and preparation systems. Barrels up to 200 liters, Hobcock containers as well as smaller original pails of liquid or viscous materials are emptied, degassed, recirculated and processed accordingly in order to provide the best material preparation for the future dispensing process. These feeding systems are adapted to the process requirements.

Additional to supplying its mta<sup>®</sup> standard dispensing equipment, Unitechnologies provides the possibility for complete integration of other brands of dispensing equipment; this includes complete software integration as well as validation and capability tests prior to its realization.

The dispensing process validation tests and the machine capability analysis are realized in the mta<sup>®</sup> dispensing lab. Production of golden samples and batches are carried out under real conditions to benchmark achievable quality levels. Furthermore, Unitechnologies provides additional equipment for quality checks on the dispensed parts such as micro-cutting devices, analytical scales, high speed vision system and optical measuring tools.





## Examples of applications

### Contact lenses

- Industry: pharma
- Application: production of contact lenses
- Process: dispensing of monomer

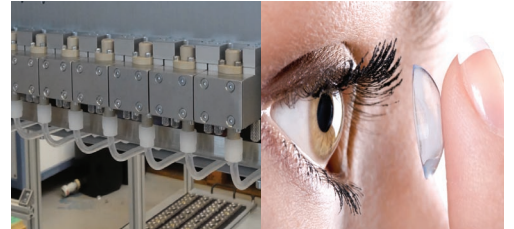

### Furniture damper

- Industry: household appliances
- Application: filling of a furniture damper
- Process: dispensing of mono-component silicon oil



### Sensor

- Industry: automotive
- Application: selective conformal coating of a sensor
- Process: globtop dispensing of two-component Epoxy







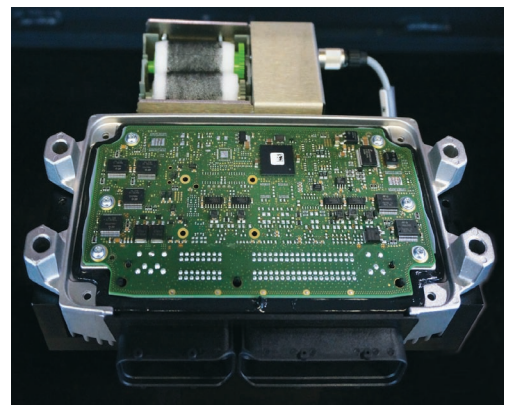
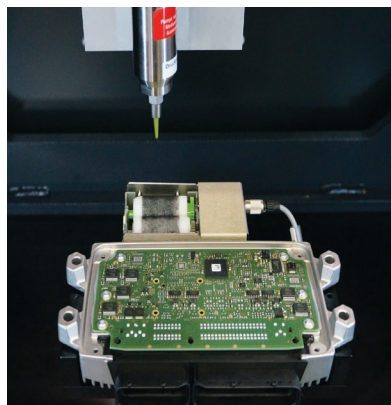

### Electronic box

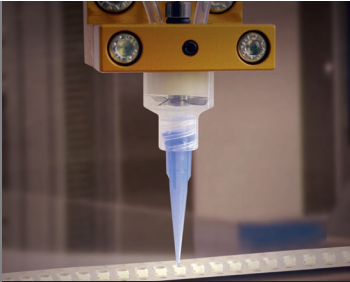
- Industry: automotive
- Application: sealing of an automotive electronic box
- Process: dispensing of mono-component silicon beads



# Dispensing configurator

Dispensing techniques		 <p><b>MRC500 robotic cell</b></p>	 <p><b>TR300 table-top robot</b></p>
	<p><b>NVD / NBD</b></p>  <p><u>Configurations</u></p> <ul style="list-style-type: none"> <li>- NVD mono-component</li> <li>- NBD two-components with mixer</li> <li>- 3D dispensing</li> <li>- With or without controller</li> </ul> <p><u>Options</u></p> <ul style="list-style-type: none"> <li>- Set up for easy, normal and difficult products</li> <li>- Mixing chamber heating</li> <li>- 1.3 liters container under pressure</li> </ul>	<p>✓</p> <p><u>Configurations</u></p> <ul style="list-style-type: none"> <li>- NVD mono-component dispenser</li> <li>- NBD two-components dispenser with mixer</li> <li>- 3D dispensing</li> <li>- Work area: 500x500 or 300x300mm</li> </ul> <p><u>Options</u></p> <p>Please see common options</p>	<p>✓</p> <p><u>Configurations</u></p> <ul style="list-style-type: none"> <li>- NVD mono-component dispenser</li> <li>- NBD two-components dispenser with mixer</li> <li>- 3D dispensing</li> <li>- Work area: 300x300mm</li> </ul> <p><u>Options</u></p> <ul style="list-style-type: none"> <li>- Back loading and/or unloading</li> <li>- For further options, please see below</li> </ul>
	<p><b>Mini-NVD / Mini-NBD</b></p>  <p><u>Configurations</u></p> <ul style="list-style-type: none"> <li>- Mini-NVD mono-component</li> <li>- Mini-NBD two-components with mixer</li> <li>- 3D dispensing</li> <li>- With or without controller</li> </ul> <p><u>Options</u></p> <ul style="list-style-type: none"> <li>- Set up for easy, normal and difficult products</li> <li>- Mixing chamber heating</li> <li>- 1.3 liters container under pressure</li> </ul>	<p>✓</p> <p><u>Configurations</u></p> <ul style="list-style-type: none"> <li>- Mini-NVD mono-component dispenser</li> <li>- Mini-NBD two-components dispenser with mixer</li> <li>- 3D dispensing</li> <li>- Work area: 500x500 or 300x300mm</li> </ul> <p><u>Options</u></p> <p>Please see common options</p>	<p>✓</p> <p><u>Configurations</u></p> <ul style="list-style-type: none"> <li>- Mini-NVD mono-component dispenser</li> <li>- Mini-NBD two-components dispenser with mixer</li> <li>- 3D dispensing</li> <li>- Work area: 300x300mm</li> </ul> <p><u>Options</u></p> <ul style="list-style-type: none"> <li>- Back loading and/or unloading</li> <li>- For further options, please see below</li> </ul>
	<p><b>CFD / CBD</b></p>  <p><u>Configurations</u></p> <ul style="list-style-type: none"> <li>- CFD mono-component</li> <li>- CBD two-components with mixer</li> <li>- 3D dispensing</li> <li>- With or without controller</li> </ul> <p><u>Options</u></p> <ul style="list-style-type: none"> <li>- Set up for easy, normal and difficult products</li> <li>- Mixing chamber heating</li> <li>- 1.3 liters container under pressure</li> </ul>	<p>✓</p> <p><u>Configurations</u></p> <ul style="list-style-type: none"> <li>- CFD mono-component dispenser</li> <li>- CBD two-components dispenser with mixer</li> <li>- 3D dispensing</li> <li>- Work area: 500x500 or 300x300mm</li> </ul> <p><u>Options</u></p> <p>Please see common options</p>	<p>✓</p> <p><u>Configurations</u></p> <ul style="list-style-type: none"> <li>- CFD mono-component dispenser</li> <li>- CBD two-components dispenser with mixer</li> <li>- 3D dispensing</li> <li>- Work area: 300x300mm</li> </ul> <p><u>Options</u></p> <ul style="list-style-type: none"> <li>- Back loading and/or unloading</li> <li>- For further options, please see below</li> </ul>
<p><b>CD</b></p>  <p><u>Configurations</u></p> <ul style="list-style-type: none"> <li>- With or without controller</li> </ul>	<p>✓</p> <p><u>Configurations</u></p> <ul style="list-style-type: none"> <li>- CD mono-component dispenser only</li> <li>- Work area: 500x500 or 300x300mm</li> </ul> <p><u>Options</u></p> <p>Please see common options</p>	<p>✓</p> <p><u>Configurations</u></p> <ul style="list-style-type: none"> <li>- CD mono-component dispenser only</li> <li>- Work area: 300x300mm</li> </ul> <p><u>Options</u></p> <ul style="list-style-type: none"> <li>- Back loading and/or unloading</li> <li>- For further options, please see below</li> </ul>	
<p><b>Common options:</b> remote support "team viewer", monitoring black and white or color, presence detection of parts, height measuring level control, mobile or fix needle cleaning device, needle recentering (X,Y,Z), vision system for quality inspection, vision system for</p>		<p><b>Common options:</b> remote support "team viewer", monitoring black and white or color, presence detection of parts, height measuring level control, mobile or fix needle cleaning device, needle recentering (X,Y,Z), vision system for quality inspection, vision system for</p>	



mta

SOLDERING & DISPENSING

### Dispensing platforms



OEM300 robot



Configurations

- NVD mono-component dispenser
- NBD two-components dispenser with mixer
- 3D dispensing
- Work area: 300x300mm or 500x500mm

Options

Please see common options

probe of parts, signalization column, recentering and customer specific fixture.



Station



Configurations

- NVD mono-component dispenser
- NBD two-components dispenser with mixer

Options

- Additional pneumatic axes



MultiFlex



N/A



Configurations

- Mini-NVD mono-component dispenser
- Mini-NBD two-components dispenser with mixer
- 3D dispensing
- Work area: 300x300 or 500x500mm

Options

Please see common options

probe of parts, signalization column, recentering and customer specific fixture.



Configurations

- Mini-NVD mono-component dispenser
- Mini-NBD two-components dispenser with mixer

Options

- Additional pneumatic axes



Configurations

- 2 to xx Mini-NVD mono-component dispensers

Only upon request of a specific quotation



Configurations

- CFD mono-component dispenser
- CBD two-components dispenser with mixer
- 3D dispensing
- Work area: 300x300mm or 500x500mm

Options

Please see common options

probe of parts, signalization column, recentering and customer specific fixture.



Configurations

- CFD mono-component dispenser
- CBD two-components dispenser with mixer
- 3D dispensing

Options

- Additional pneumatic axes



N/A



Configurations

- CD mono-component dispenser only
- Work area: 300x300 or 500x500mm

Options

Please see common options

probe of parts, signalization column, recentering and customer specific fixture.



Configurations

- CD mono-component dispenser only

Options

- Additional pneumatic axes



N/A

## Platform controllers

### Robotic cell and table-top robot

The mta® standard platforms, such as the MRC500 robotic cell and the TR300 table-top robot, are controlled using an industrial PC, running a WINDOWS operating system. The PC and all the hardware needed to control the robot and the processes are integrated and delivered within the standard platforms. State-of-the-art connection and interfaces are already integrated in order to communicate with other systems, controllers, etc.

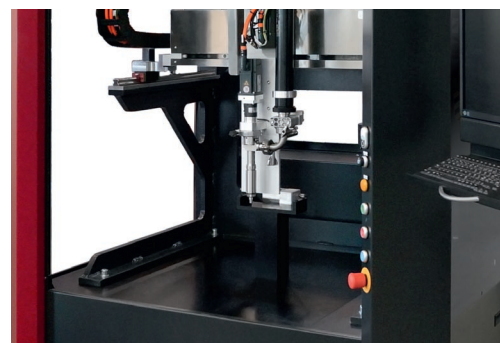

### OEM and station for integrator

#### Software/controller configurator

Techniques	Motion Editor	Station Configurator	Controller type
NVD	✓	✓	Mini station
NVD + 1 Z axis- pneumatic	✓	✓	Mini station
NVD + 1 Z axis- numerical	✓		19" Rack
Mini-NVD	✓	✓	Mini station
Mini-NVD + 1 Z axis- pneumatic	✓	✓	Mini station
Mini-NVD + 1 Z axis- numerical	✓		19" Rack
NBD	✓		19" Rack
NBD + 1 Z axis (pneumatic or numerical)	✓		19" Rack
CFD	✓		19" Rack
CFD + 1 Z axis (pneumatic or numerical)	✓		19" Rack
CD	✓		19" Rack
CD + 1 Z axis (pneumatic or numerical)	✓		19" Rack
Jet dispenser	✓		Specific controller
Jet dispenser + 1 Z axis (pneumatic or numerical)	✓		Specific controller

### Electrical controllers

Embedded solutions are proposed and consist of either an electrical controller in the shape of a 19" rack or of a mini-station controller. Both systems are completely autonomous and require a 230V power supply.

With the 19" rack, a process with up to two optional numerical axes can be managed.

The mini station is available for certain simpler configurations. It includes a 24V power supply and contains everything necessary to use certain mta® processes within a relatively reduced space.



## mta® software

With more than 20 years of experience in the design/creation of software dedicated to dispensing processes, the mta® solutions offered by Unitechnologies propose a large range of possibilities to accelerate the integration of the controllers. The software is permanently evolving and covers the entirety of the needs spotted in the mta® laboratories and by the customers.

Two software applications are available to enable the operator to interact with the mta® controller electronics. The mta® proprietary software applications MotionEditor and Station Configurator offer a large number of functions simplifying the use of the available processes. These software applications can be integrated into all platforms of the mta® product range.

With the mta® MotionEditor software, the operator can access the different parameters and execute cycles from a single window. Its modular basis accommodates all mta® processes. Furthermore, its .Net C# programming opens the door to the integration of new functions according to the customer's specific needs. It consists of a main window which indicates the current status and of a "sequence" window from which the operator can add or remove actions in a cycle. The operator is in charge of the order of execution of the various operations and of the general behavior of the system.

Stations with a simpler process can easily be managed by a PLC to execute an action. In this system, the mta® electrical controllers are integrated by the customer and are managed as slaves via an I/O communication protocol. The mta® Station Configurator software is used to edit the parameters of the PLC via a serial communication. The station only requires a connection to a laptop through which a qualified operator can enter the parameters so that the stations can then work autonomously. An industrial PC dedicated to this task can be offered as an option.

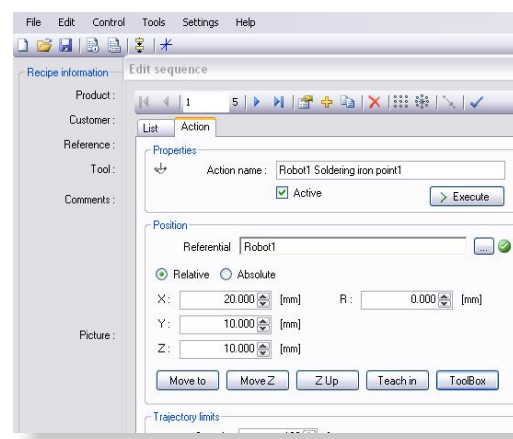

## Software comparison

	MotionEditor	Station Configurator
<b>Environment</b>	Windows	Windows / PLC
<b>HMI</b>	full graphic interface	parameter editor
<b>Interface with mta® station</b>	CAN or serial (RS232)	PLC integrated to the station
<b>Interface with the customer</b>	digital I/O, RS232, Ethernet	digital I/O
<b>System</b>	full control via a sequence editor	process parameter setting for one point
<b>Receipt</b>	unlimited receipt number	16 receipts of a programmable point
<b>Specificity</b>	adustable I/O and numerical axis number	runs in cycle without PC
<b>Extension possibility</b>	additional functionalities as needed	none



## Providing turnkey solutions

With almost 50 years of experience in automation, Unitechnologies can propose the best possible solution available for the realization of turnkey systems for all automation processes peripheral to the soldering and dispensing operations.

The highly qualified staff, state-of-the-art infrastructure and proven methods of managing knowledge and mastering risks are key factors to innovative solutions perfectly adapted to the customer's needs.

Unitechnologies' workforce faces daily challenges in mastering multidisciplinary projects. The open minded corporate culture facilitates the integration of external competences into company internal skills, resulting in a high level of success for all partners involved in an automation project.



## Assembly line example

### Product

Pressure sensor for the medical industry.

### Operations

- Assembly of wires and moulding.
- Dispensing of solder paste.
- Soldering of wires on a ceramic substrate.

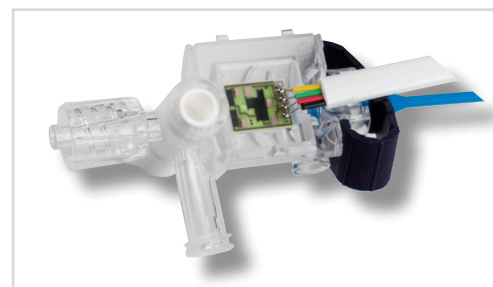





mta

SOLDERING & DISPENSING

## Key competences

### Integration of assembly processes

- Specific attachments processes such as laser, welding, gluing or crimping
- High precision, shock-free numerical positioning
- Handling of delicate or elastic components

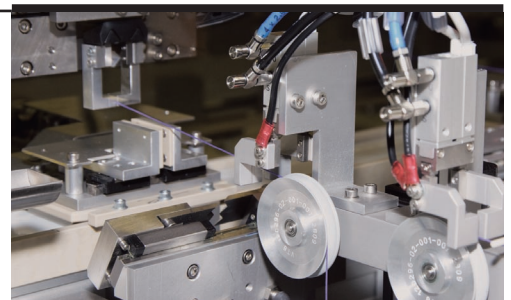

### Integration of on-line measuring systems

- Multicamera vision systems
- Analogical physical signals
- Force measurement systems

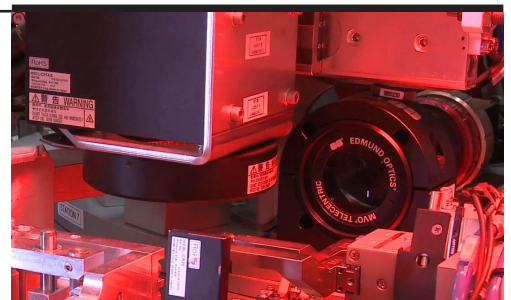

### High performance project management

- Realization of customized machines
- Multidisciplinary coordination with several partners
- Machine validation according to DQ, IQ and OQ procedures



### Expertise in the architecture of automated systems

- Methodological approach including product design analysis
- Extensive expertise of microtechnical technologies
- Mastering of extreme flexibility constraints

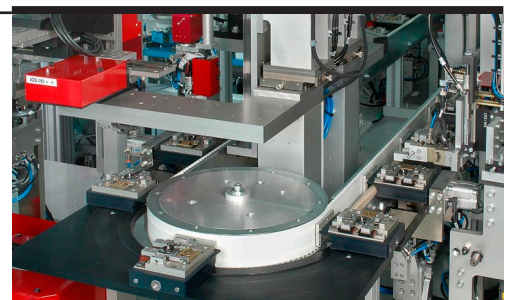

### Mastery of numerical technologies and robotics

- High precision robotics
- Integration of multi-axis robots from the market
- Automation of tools according to specific requirements

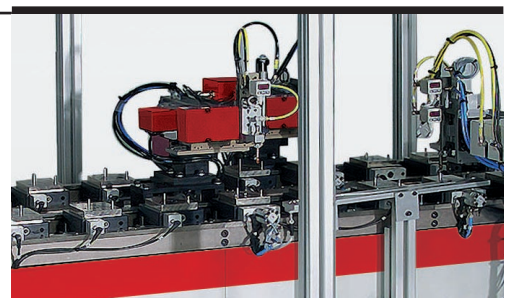

## Dispensing consumables

### Piston/cylinder pumps

The pumps integrated in the mta® dispensing solution are made of ceramic piston/cylinder.

The pumps are well known for their precision and long life span; they provide efficient results. In addition, the neutral ceramics components avoid any kind of contamination of the dispensed products.

The standard mta® product range provides the three following options based on the volume to be dispensed:

- NVD-0 for maximum 1'250 mm<sup>3</sup>/stroke
- NVD-1 for maximum 710 mm<sup>3</sup>/stroke
- NVD-2 for maximum 315 mm<sup>3</sup>/stroke

mta® custom designed dispensing solutions are also provided for all kind of applications, even when material certificates are required for FDA compliance.



Article number	Description
7-0354-00-000-10	Piston/cylinder set NVD-0
7-0692-00-000-00	Seal set NVD-0
7-0349-00-000-10	Piston/cylinder set NVD-1
7-0693-00-000-00	Seal set NVD-1
7-0352-00-000-10	Piston/cylinder set NVD-2
7-0694-00-000-00	Seal set NVD-2
4-0164-11-000-00	Mini-NVD pump case



mta

SOLDERING & DISPENSING

## Dispensing consumables

### Mixing chambers

The mta® mixing chamber is a unique solution on the market based on a dynamic mixing chamber. This unit made of stainless steel and plastic has been designed to either be cleaned or changed after use depending on the mixed material type. In terms of maintenance of the whole equipment, it is a clear advantage to have the material being mixed just before dispensing. The dispensing nozzles are directly connected to the mixing chamber.

This chamber homogeneously mixes A and B material by using a rotating blender. In order to optimize the mixing effect, the rotational speed can be electronically controlled. This solution is perfectly adapted to small volumes. The mixing quality can be achieved by adapting mixing time, mixer speed and mixing chamber volume. Four standard mixing chamber sizes are available: 200, 600, 1500 and 2300.



Article number	Description
4-0085-05-000-00	Mixing chamber CM200
4-0085-01-000-02	Mixing chamber CM600
4-0085-02-000-02	Mixing chamber CM1500
4-0085-03-000-02	Mixing chamber CM2300

### Dispensing nozzles

The mta® process guarantee also includes the selection of the most suitable nozzles for customer's specific applications, as defined during the tests in the laboratories. Based on a proven experience in the dispensing field, the appropriate nozzles among a very large choice of components can be selected. Dispensing nozzles are available in different sizes, shapes and material. Most of the variants are available from stock. Custom designed nozzles are also offered.



### Cleaning sponges

mta® brand has a proprietary design for the tip cleaning units which consist of two rotating sponges. The sponges must be replaced from time to time.





mta

SOLDERING & DISPENSING

# THE ART OF PRECISION

---

## Headquarters

### **Unitechnologies SA**

Bernstrasse 5  
CH-3238 Gals  
Switzerland

T +41 32 338 80 80  
F +41 32 338 80 99  
info@unitechnologies.com  
www.unitechnologies.com

## Subsidiary USA

### **mta automation inc.**

50-1 River Street  
US-Old Saybrook, CT 06475  
USA

T +1 860 399 1141  
F +1 860 399 1159  
info@mtaautomation.com  
www.mtaautomation.com



unitechnologies

THE ART OF PRECISION