



mta

SOLDERING & DISPENSING

## Selective soldering solutions



unitechnologies

THE ART OF PRECISION

## Summary

<b>From concept to turnkey solutions</b> .....	<b>p 3</b>
<b>Services &amp; support</b> .....	<b>p 3</b>
<b>Point to point selective soldering</b> .....	<b>p 4</b>
Examples of applications.....	p 4
<b>Soldering techniques</b> .....	<b>p 5-7</b>
Classic soldering iron.....	p 5
MSH150 soldering iron .....	p 5
Induction .....	p 6
Microflame.....	p 6
PowerLas laser .....	p 7
Solder paste dispensing for laser and induction .....	p 7
<b>Soldering standard platforms</b> .....	<b>p 8-13</b>
MRC500 robotic cell.....	p 8
MRC500 laser robotic cell .....	p 9
TR300 table-top robot .....	p 10
OEM robot for integrator .....	p 11
Station for integrator.....	p 12
Classic soldering wire feeder platform .....	p 13
<b>Soldering configurator</b> .....	<b>p 14-15</b>
<b>Platform controllers</b> .....	<b>p 16</b>
Robotic cell and table-top robot.....	p 16
OEM and station for integrator .....	p 16
<b>mta® software</b> .....	<b>p 17</b>
mta® software .....	p 17
Software comparison .....	p 17
<b>Providing turnkey solutions</b> .....	<b>p 18</b>
<b>Assembly line examples</b> .....	<b>p 18</b>
<b>Key competences</b> .....	<b>p 19</b>
<b>Solder consumables</b> .....	<b>p 20</b>
<b>Solder tips</b> .....	<b>p 21-25</b>
<b>Own mta® solder wires</b> .....	<b>p 26</b>
<b>Distributor solder wires</b> .....	<b>p 27</b>
<b>Other solder consumables</b> .....	<b>p 27</b>

## From concept to turnkey solutions

Unitechnologies SA, with its mta® brand, is the leader in selective soldering processes based on standardized platforms. The product range includes components, standalone systems, semi-automatic table-top robots and entirely automatic production cells or lines.

Thanks to a complete infrastructure, trials can be carried out on samples using all proven mta® soldering techniques in the company's test laboratories.

Once the mta® technique has been validated, a detailed quotation is established with the proposed standard machine adapted to the customer's specifications.

For the peripheral automation processes of the soldering operations, turnkey automated lines are also offered.

Unitechnologies mechanical and software engineers, designers and technicians provide on-site installation and training to customers as well as worldwide after-sales services.



## Services & support

### Test laboratories

During the feasibility studies in the soldering laboratory, the physical properties of the applications and other elements are studied down to the smallest detail. Based on this analysis, the most appropriate mta® soldering techniques can be defined for each specific application and a detailed report confirming the feasibility and the characteristics can be established.

### Process & innovation

mta® process specialists constantly work to develop innovative products and services in-line with the market's development and the specific needs of customers.

### Customer services

The Unitechnologies' customer services can provide advice, remote or onsite intervention with speed and reliability. With a large range of spare parts in stock, the customer's system will stay at the cutting edge of technology.

### Worldwide presence

As a partner to numerous companies in industries such as automotive, electronics, medical, watchmaking, telecom and household appliances, Unitechnologies has an international sales and distribution network dedicated to advice, sales and customer support.

### Swiss quality

More than 3'500 mta® systems produced and installed throughout the world meet the customer's expectations in terms of quality thanks to "Swiss made" criteria and to a rigorous application of a certified ISO 9001 quality management system.



## Point to point selective soldering

With the point to point selective soldering technique, very specific points to be soldered can be selected. Compared to soldering on defined areas, this enables a higher accuracy and the possibility of adapting the soldering parameters to the requirements of each individual point.

As alternative to manual soldering, the point to point soldering automated solutions guarantee a high soldering quality as they are much more repeatable and reliable than working with soldering operators.

The ability of the components to be soldered in the customer's application is tested in the mta® soldering laboratory. During these feasibility studies, properties such as material, surface treatment, alloy structure of the solder wire and the type of flux are analyzed.

After this complete analysis, the most appropriate soldering technique is chosen from the mta® product range: soldering iron, laser, induction or microflame. These techniques are detailed on pages 5, 6 and 7.

All of the above mentioned soldering techniques can be integrated into the various mta® standard platforms, adapted for fully automatic or semi-automatic operations, such as the MRC500 robotic cell, the TR300 tabletop robot, the OEM robot or the station. The soldering platforms are detailed on pages 8 to 12.

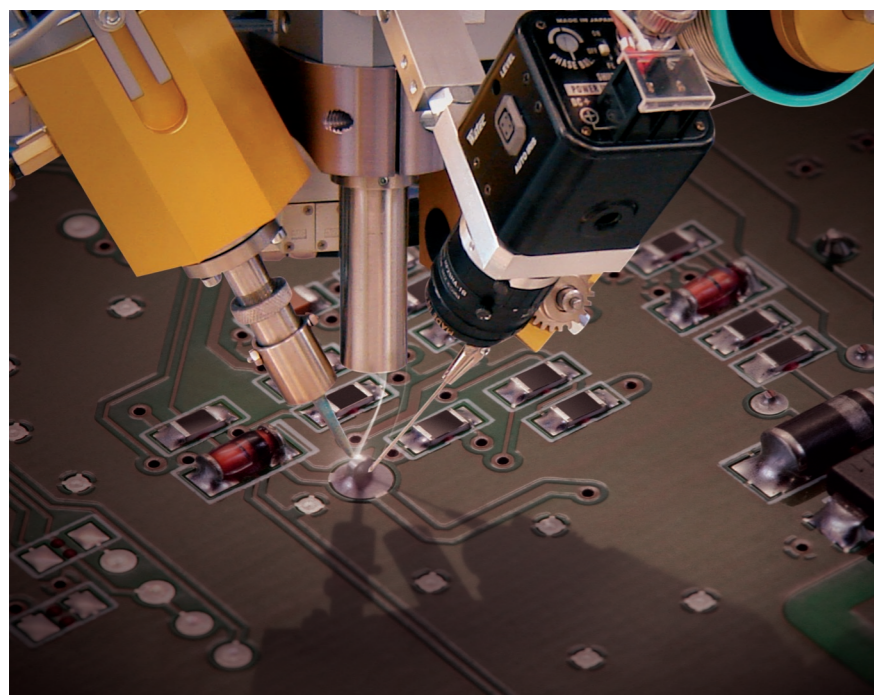

### Examples of applications

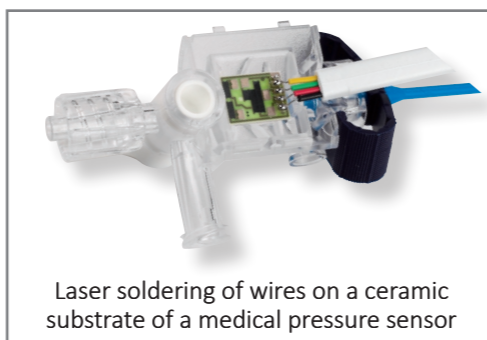

Laser soldering of wires on a ceramic substrate of a medical pressure sensor

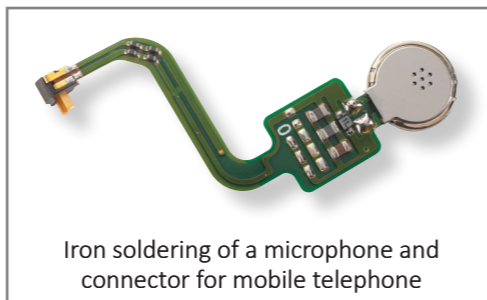

Iron soldering of a microphone and connector for mobile telephone

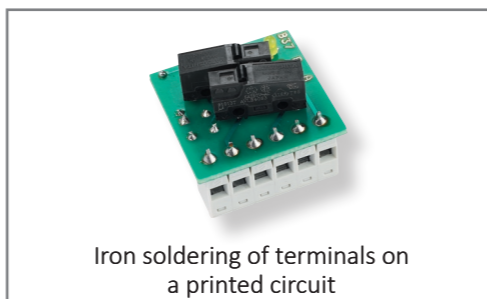

Iron soldering of terminals on a printed circuit



Induction soldering of a temperature sensor

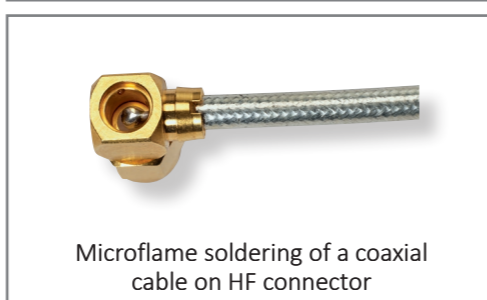

Microflame soldering of a coaxial cable on HF connector

## Soldering techniques

### Classic soldering iron

- Easy access to all mechanical settings of the soldering iron head
- Solder tip long life span
- Easy and fast tip changeover
- Guaranteed repeatability of tip position after changeover
- Specific tips according to the application
- \*Controlled wire presence and feeding
- \*Lead free compatible

#### Technical specifications

<b>Iron power</b>	80W or 150W/24VAC
<b>Iron temperature</b>	adjustable to 450°C (837°F) and standby mode
<b>Temperature accuracy</b>	± 5°C (regulation over a 4-20mA current loop)
<b>Plug-in connection</b>	25-pole sub-D male
<b>Power supply controller</b>	115/230V- 50/60Hz
<b>Air pressure</b>	max. 6 bar
<b>Iron head dimensions</b>	292 x 225 x 184 mm
<b>Iron head weight</b>	~2.9 kg
<b>*Solder wire diameter</b>	0.3 - 1.2 mm (1.6 mm upon request)
<b>*Solder wire qty accuracy</b>	±2.5% / Power supply: 24VDC

*\*applicable to all soldering techniques*

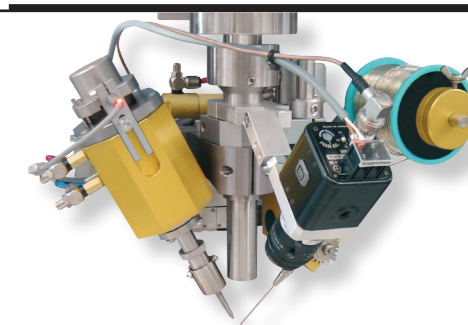

### MSH150 soldering iron

- Numerous easily accessible mechanical adjustments indicated by colored markings
- Graduated scale to easily return to previous product and process adjustments
- Embedded temperature controller, PID regulator close to the process
- Compact, light and rigid structure, ensuring excellent process stability and reduced cycle times
- Solder tip long life span
- Easy and fast tip changeover with guaranteed repeatability of tip position
- Specific tips according to the application

#### Technical specifications

<b>Iron power</b>	150W
<b>Iron temperature</b>	adjustable to 450°C (837°F) and standby mode
<b>Temperature accuracy</b>	± 2°C (regulation over a 4-20mA current loop)
<b>Plug-in connection</b>	integrated in the head
<b>Power supply controller</b>	24V
<b>Air pressure</b>	max. 6 bar
<b>Iron head dimensions</b>	200 x 200 x 180 mm (without monitoring camera)
<b>Iron head weight</b>	~2.3 kg



## Soldering techniques

### Induction

- Large heating capacity
- Dimension and geometry of the spire according to the application
- Entirely transistorized system
- Suitable for brazing (hard alloy)
- The non-conductive parts of the components to be soldered are not heated by the induction
- Contact-less soldering

Technical specifications	
Induction head coil power	max. 32kVar or 45kVar
Induction head coil diameter	min. 4 mm and max. 12 mm
Induction head dimensions	123 x 95 x 62.5 mm
Induction head weight	~2 kg
Generator dimensions	275 x 265 x 140 mm
Generator weight	~10 kg
Generator power supply	230V/50-60Hz
Chiller	pressure: min. 3.5 bar- supply: 1.5 - 2 l/min.
Controller dimensions	275 x 265 x 140 mm
Controller weight	~5.7 kg

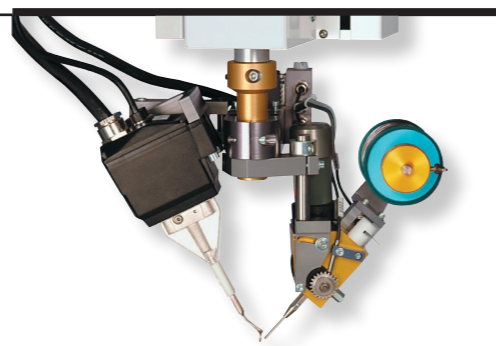

### Microflame

- Pivoting flame allowing immediate temperature release, thus preventing the part from overheating
- Gas produced from demineralized water electrolysis
- Fast-action flame nozzle swiveling (patented system)
- Automatic lighting
- Constant and reproducible energy flow
- Contact-less soldering

Technical specifications	
Generator flow	200 l/h - 40-170 mBar
Generator power supply	115/230V- 50/60 Hz- 700W
Detector for nozzle rotation	2 x24VDC / Reed relais NO
Plug-in connection	25-pole sub-D male
Nozzle connection	with Luer lock
Chimney	ceramics
Power supply controller	115/230V- 50/60Hz
Air pressure	max. 6 bar
Microflame head dimensions	280 x 180 x 190 mm
Microflame head weight	~2.1 kg

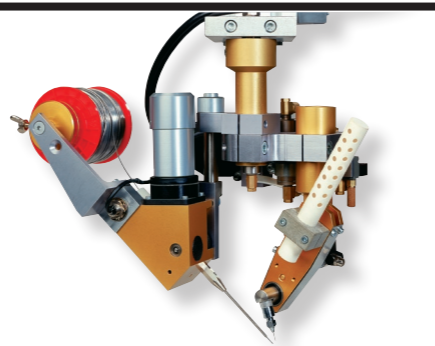

## Soldering techniques

### PowerLas laser

- Uniform solder joint heating
- Digitally adjustable focus for different solder joint sizes
- Easy teaching with integrated monitoring and laserpointer
- Optical realignment and fiducials recognition
- Diode laser with optical fiber
- Contact-less soldering

Technical specifications	
Laser power	66W
Cooling system	air cooled
Wavelength	940nm
Heating profile	mta® PowerLas (through hole)
Laser spot diameter	0.3 - 2.6 mm (digitally adjustable)
Laser positioning system	integrated to the laser beam
Laser source power supply	230V/50Hz or 115V/60Hz
Air pressure	max. 6 bar
Laser head dimensions	180 x 130 x 190 mm
Laser head weight	~3 kg

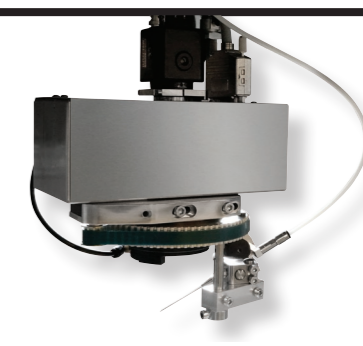

### Solder paste dispensing for laser and induction

As the soldering market is heading towards smaller and smaller applications, the size of the solder wire and the influence of its contact with the components become a limit for the achievable process accuracy.

In order to ensure the excellence of its induction and laser processes with the smallest parts, Unitechnologies now has the capability to integrate mta® solder paste dispensing devices directly next to the soldering head, within the same equipment.

The proximity between the solder paste dispenser and the soldering process ensures a perfect mastering of the complete process. Moreover, due to the complete integration of both process steps within the same automated equipment, the investment costs can be optimized.

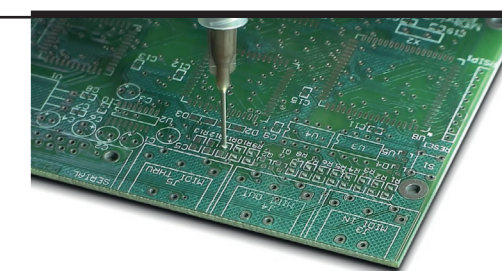

## Soldering standard platforms

### MRC500 robotic cell

The PC controlled MRC500 standard robotic cell can be used for semi or fully automatic operations of selective point to point soldering from above.

The MRC500 can be equipped with the established mta® soldering techniques such as iron soldering, induction and microflame described on the previous pages.

The 3 or 4 axes of the MRC500 are fully programmable through the mta® MotionEditor software including soldering parameters such as:

- Solder quantity, wire feed speed, preheating/postheating times, automatic tip cleaning cycle intervals and other parameters for each soldered point.

Thanks to its flexible and modular concept, the MRC500 has an open architecture and can easily be integrated into existing production lines with pallet conveyors or a rotary table.

The MRC500 robotic cell provides standardized automation solutions with the highest quality and repeatability for all customer's specific applications.



Technical specifications	
Working area	500 x 500 x 200 mm or 300 x 300 x 200 mm (MRC300)
Cartesian robot	3 or 4 axes (option: axis T)
Shift of axes	point by point
Positioning repeatability	±20 µm
Speed	X and Y: <300mm/s, Z <150mm/s, T <=3.8 rad/s
Electronic control	industrial PC
Operating system	WINDOWS
Programming	HMI Windows oriented
Interfaces	Ethernet / USB port / Serial port
Execution mode	Standalone or slave with PLC via I/O interface
X, Y and Z axes actuation	Servomotors- Axis T: stepper motor
Power supply	400/208V- 50/60Hz
Power consumption	1 kVA
Air pressure	max. 6 bar
Dimensions	1'425 x 1'420 x 2'250 mm
Weight	~650 kg

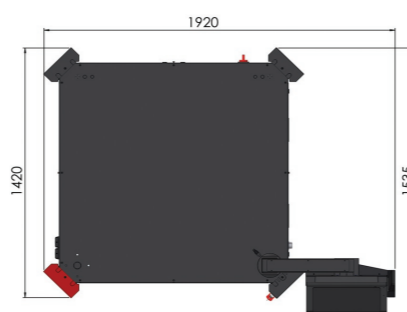
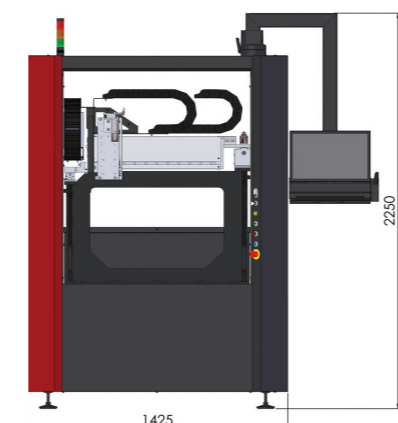

## Soldering standard platforms

### MRC500 laser robotic cell

The PC controlled MRC500 laser robotic cell can be used for semi or fully automatic operations of selective point to point soldering from above.

The frame of the MRC500 is specifically designed to ensure the safety of the operator during the laser soldering process, as well as to provide maximum accessibility to the working area. It is equipped with the mta® PowerLas soldering laser technique described on the previous page.

The 3 axes of the MRC500 are fully programmable through the mta® MotionEditor software, including soldering parameters such as:

- Solder quantity, wire feed speed, preheating/postheating times, laser power, spot size and other parameters for each soldered point.

The MRC500 robotic cell provides standardized automation solutions with the highest quality and repeatability for all customers' specific applications.



Technical specifications	
Working area	500 x 500 x 200 mm
Cartesian robot	3 axes
Shift of axes	point by point
Positioning repeatability	±20 µm
Speed	X and Y: <300mm/s, Z <150mm/s
Electronic control	industrial PC
Operating system	WINDOWS
Programming	HMI Windows oriented
Interfaces	Ethernet / USB port / Serial port
Execution mode	Standalone or slave with PLC via I/O interface
X, Y and Z axes actuation	Servomotors
Power supply	400/208V- 50/60Hz
Power consumption	1.5 kVA
Air pressure	max. 6 bar
Dimensions	1'405 x 1'492 x 2'532 mm
Weight	~1'000 kg

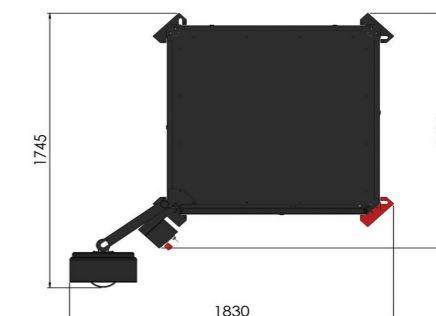
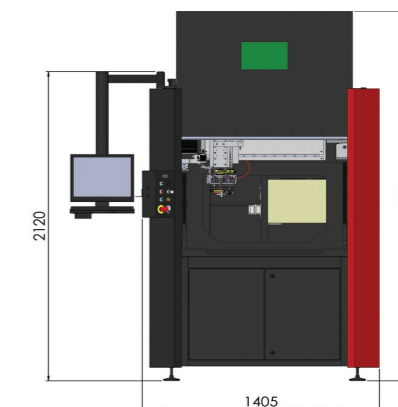

## Soldering standard platforms

### TR300 table-top robot

The PC controlled TR300 standard table-top robot can be used for semi-automatic operations of selective point to point soldering from above.

The increasing requirements for processes in terms of quality, precision and repeatability lead to a similar increase in the necessary level of automation. However, when production batches are small or products widely dissimilar, the cost of sophisticated equipment can place automation beyond the reach of many would-be users. The TR300 combines the necessary flexibility with the required high levels of process quality and repeatability, all at reasonable cost.

The TR300 can be equipped with all the established mta® soldering techniques described on the previous pages.

The 3 or 4 axes of the TR300 are fully programmable through the mta® MotionEditor software including soldering parameters such as:

- Solder quantity, wire feed speed, preheating/postheating times, automatic tip cleaning cycle intervals and other parameters for each soldered point.



#### Technical specifications

<b>Working area</b>	300 x 300 x 100 mm
<b>Cartesian robot</b>	3 or 4 axes (option: axis T)
<b>Shift of axes</b>	point by point
<b>Positioning repeatability</b>	±20 µm
<b>Speed</b>	X and Y: <200mm/s, Z <100mm/s, T <=3.14 rad/s
<b>Electronic control</b>	industrial PC
<b>Operating system</b>	WINDOWS
<b>Programming</b>	HMI Windows oriented
<b>Interfaces</b>	Ethernet / USB port / Serial port
<b>Execution mode</b>	Standalone or slave with PLC via I/O interface
<b>Axis actuation</b>	step by step motor
<b>Power supply</b>	230/115V- 50/60Hz
<b>Power consumption</b>	1 kVA
<b>Air pressure</b>	max. 6 bar
<b>Dimensions</b>	804 x 732 x 995 mm
<b>Weight</b>	~125 kg

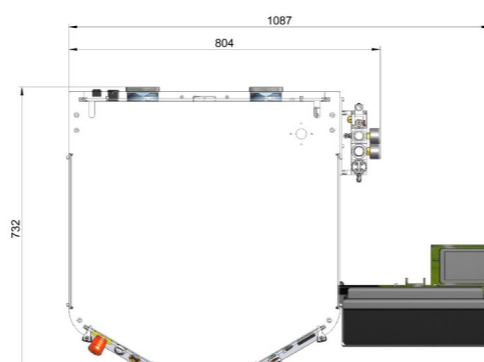
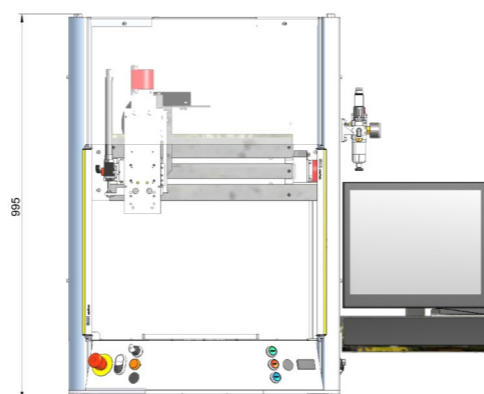

## Soldering standard platforms

### OEM robot for integrator

The PC controlled OEM standard robot can be used for semi or fully automatic operations of selective point to point soldering from above.

Thanks to its unique concept, the OEM robot is delivered to the system's manufacturer with a process guarantee.

The OEM robot can be equipped with all the established mta® soldering techniques, except for the mta® PowerLas laser.

The 3 or 4 axes of the OEM robot are fully programmable through the mta® MotionEditor software including soldering parameters such as:

- Solder quantity, wire feed speed, preheating/postheating times, automatic tip cleaning cycle intervals and other parameters for each soldered point.

With its flexible and modular concept, the OEM robot can be fully and easily integrated into a production line (no safety guarding included).

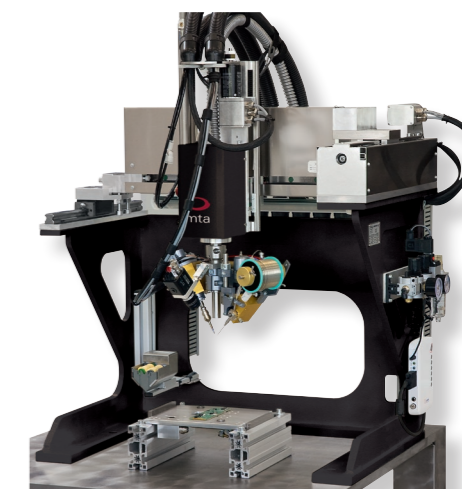

#### Technical specifications

<b>Working area</b>	300 x 300 x 200 mm or 500 x 500 x 200 mm
<b>Cartesian robot</b>	3 or 4 axes (option: axis T)
<b>Shift of axes</b>	point by point
<b>Positioning repeatability</b>	±20 µm
<b>Speed</b>	X and Y: <250mm/s, Z <150mm/s, T <=3.14 rad/s
<b>Electronic control</b>	industrial PC
<b>Operating system</b>	WINDOWS
<b>Programming</b>	HMI Windows oriented
<b>Interfaces</b>	Ethernet / USB port / Serial port
<b>Execution mode</b>	Standalone or slave with PLC via I/O interface
<b>X, Y and Z axes actuation</b>	DC Brushless motors Axis R: step by step motor
<b>Power supply</b>	230/115V- 50/60Hz
<b>Power consumption</b>	1.1 kVA
<b>Air pressure</b>	max. 6 bar
<b>Dimensions</b>	756 x 585 x 933 mm
<b>Weight</b>	~150 kg

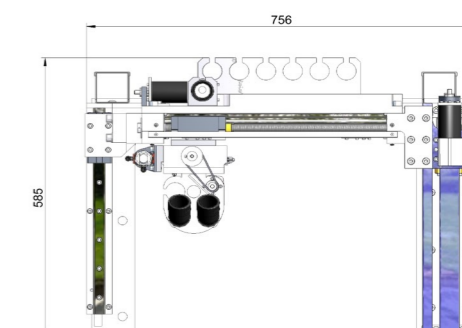
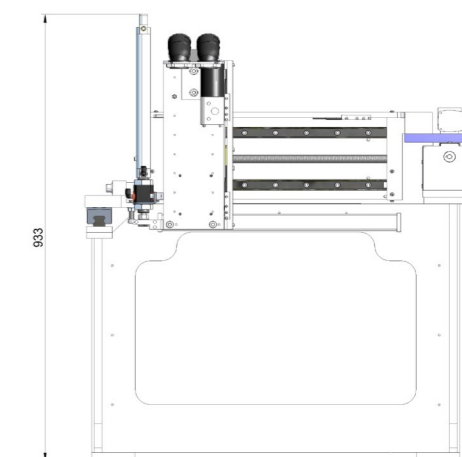

## Soldering standard platforms

### Station for integrator

For applications that do not require the flexibility of a robot, a simple station is available for semi or fully automatic operations of selective point to point soldering from above.

The modularity of slides and standard elements enable to find a solution adapted to the customer's application.

The station can be equipped with all the established mta® soldering techniques, except for the mta® PowerLas laser.

Thanks to its modular concept, the station can be integrated into a line or onto a rotary table (no safety guarding included).

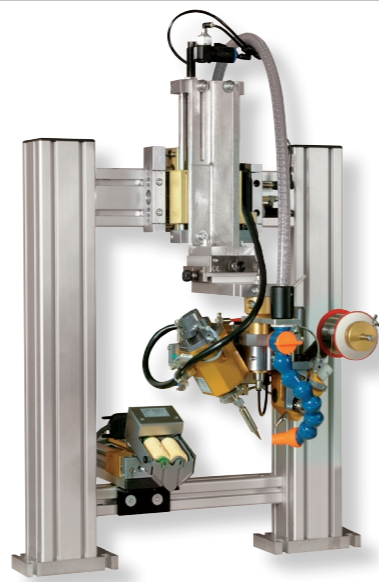

#### Technical specifications

<b>Work area</b>	according to the customer's needs
<b>Axes</b>	pneumatic
<b>Controller</b>	mta® controller available upon request
<b>Interfaces</b>	via I/O
<b>Power supply</b>	without controller 24VDC
<b>Power supply</b>	with mta® controller: 230/115V- 50/60Hz
<b>Power consumption</b>	1.1 kVA
<b>Air pressure</b>	max. 6 bar
<b>Dimensions</b>	from 470 x 630 x 810 mm to specific dimensions
<b>Weight</b>	variable from 50 kg to 100 kg

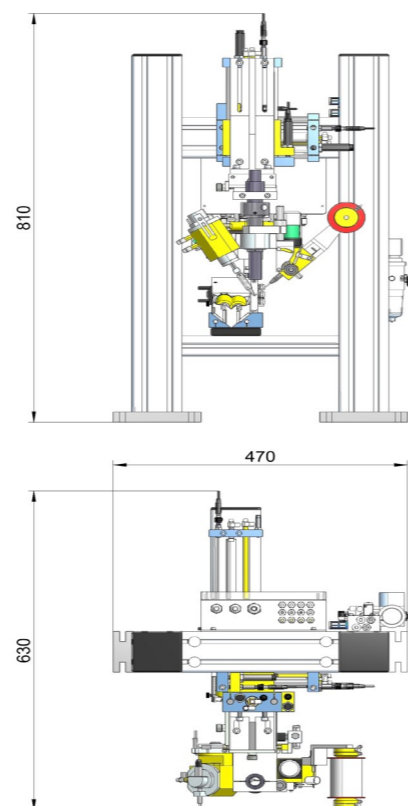

## Classic soldering wire feeder platform

### Standard wire feeder

Article number	Description
5-0005-01-200-40	Complete wire feeder

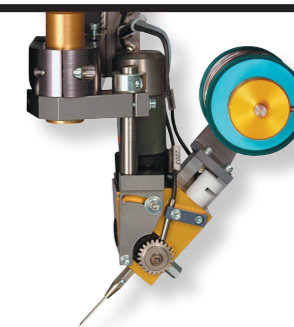

### Standard wire-guide kits

Wire diameter mm	Kit number	Wire pass	Exit-guide	Press-roller kit	Sliding wheel kit
0.3	5-0048-13-000-30	5-0048-00-600-00	7-0366-00-000-00	7-0327-00-000-00	7-0440-00-000-00
0.5	5-0048-01-000-30	5-0048-00-100-00	7-0208-00-000-00	7-0209-00-000-00	7-0440-00-000-00
0.7-0.8	5-0048-02-000-30	5-0048-00-100-00	7-0210-00-000-00	7-0211-00-000-00	7-0442-00-000-00
0.9-1.0	5-0048-03-000-30	5-0048-00-100-00	7-0212-00-000-00	7-0213-00-000-00	7-0442-00-000-00
1.2	5-0048-04-000-30	5-0048-00-200-20	7-0214-00-000-00	7-0215-00-000-00	7-0442-00-000-00
1.5-1.6	5-0048-05-000-30	5-0048-00-200-20	7-0263-00-000-00	7-0264-00-000-00	7-0443-00-000-00







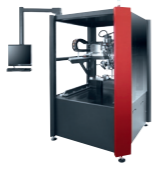

Wire diameter mm	Front-tube set 50mm	Front-tube set 60mm	Front-tube set 70mm	Tube diameter
0.3	7-0367-00-000-00	7-0368-00-000-00	7-0369-00-000-00	1.5 / 0.5
0.5	7-0219-00-000-00	7-0220-00-000-00	7-0221-00-000-00	1.2 / 0.8
0.7-0.8	7-0222-00-000-00	7-0223-00-000-00	7-0224-00-000-00	1.6 / 1.0
0.9-1.0	7-0225-00-000-00	7-0226-00-000-00	7-0227-00-000-00	2.0 / 1.3
1.2	7-0228-00-000-00	7-0229-00-000-00	7-0230-00-000-00	2.0 / 1.6
1.5-1.6	7-0265-00-000-00	7-0266-00-000-00	7-0267-00-000-00	3.0 / 2.2

### Reinforced wire-guide kits

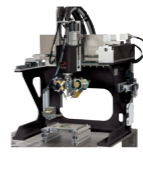
Wire diameter mm	Kit number	Wire pass	Exit-guide	Press-roller kit	Sliding wheel kit
0.3	-	-	-	-	-
0.5	5-0048-12-000-30	5-0048-00-100-00	7-0364-00-000-00	7-0209-00-000-00	7-0440-00-000-00
0.7-0.8	5-0048-14-000-30	5-0048-00-100-00	7-0391-00-000-00	7-0211-00-000-00	7-0442-00-000-00
0.9-1.0	5-0048-15-000-30	5-0048-00-100-00	7-0393-00-000-00	7-0213-00-000-00	7-0442-00-000-00
1.2	5-0048-16-000-30	5-0048-00-200-20	7-0395-00-000-00	7-0215-00-000-00	7-0442-00-000-00
1.5-1.6	5-0048-17-000-30	5-0048-00-200-20	7-0397-00-000-00	7-0264-00-000-00	7-0443-00-000-00

Wire diameter mm	Front-tube set 80mm	Front-tube set 90mm	Front-tube set 105mm	Tube diameter
0.3	-	-	-	-
0.5	7-0365-00-000-00	7-0695-00-000-00	-	1.2 / 0.8
0.7-0.8	-	7-0392-00-000-00	7-0423-00-000-00	1.6 / 1.0
0.9-1.0	-	7-0394-00-000-00	7-0421-00-000-00	2.0 / 1.3
1.2	-	7-0396-00-000-00	-	2.0 / 1.6
1.5-1.6	-	7-0398-00-000-00	-	3.0 / 2.2

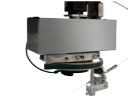
# Soldering configurator

		Soldering platforms				
		 MRC500 robotic cell	 MRC500 laser robotic cell	 TR300 table-top robot	 OEM300 robot	 Station or component
Soldering techniques	 <p><b>Classic soldering iron</b></p> <p><u>Configurations</u></p> <ul style="list-style-type: none"> <li>- Soldering iron 80W or 150W</li> <li>- With or without 19" rack</li> <li>- With or without wire feeder</li> </ul> <p><u>Options</u></p> <ul style="list-style-type: none"> <li>- Fix or mobile iron cleaning device</li> <li>- Automatic sponge humidifier</li> <li>- Set up for easy, normal and difficult products</li> </ul>	<p>✓</p> <p><u>Configurations</u></p> <ul style="list-style-type: none"> <li>- 80W or 150W soldering iron</li> <li>- 1 or 2 soldering heads</li> <li>- 3 or 4 axes</li> <li>- Work area: 500x500 or 300x300mm</li> </ul> <p><u>Options</u></p> <ul style="list-style-type: none"> <li>- Integration of a transfer system</li> <li>- SMEMA interface and conveyor</li> <li>- LED illumination set</li> </ul>	<p>✗</p> <p><u>Configuration not available</u></p>	<p>✓</p> <p><u>Configurations</u></p> <ul style="list-style-type: none"> <li>- 80W or 150W soldering iron</li> <li>- 3 or 4 axes</li> <li>- Work area 300x300mm</li> </ul> <p><u>Options</u></p> <ul style="list-style-type: none"> <li>- Back loading and/or unloading</li> <li>- Adjustable working height</li> <li>- Double-slide</li> </ul>	<p>✓</p> <p><u>Configurations</u></p> <ul style="list-style-type: none"> <li>- 80W or 150W soldering iron</li> <li>- 3 or 4 axes</li> <li>- With or without soldering iron</li> <li>- Work area: 300x300mm or 500x500mm</li> </ul> <p><u>Options</u></p> <p>Please see common options below</p>	<p>✓</p> <p><u>Configurations</u></p> <ul style="list-style-type: none"> <li>- 80W or 150W soldering iron</li> <li>- Work area: according to the customer's needs</li> </ul> <p><u>Options</u></p> <ul style="list-style-type: none"> <li>- Additional pneumatic axes</li> </ul>
	 <p><b>MSH150 soldering iron</b></p> <p><u>Configurations</u></p> <ul style="list-style-type: none"> <li>- Soldering iron 150W</li> <li>- With or without wire feeder</li> </ul> <p><u>Options</u></p> <ul style="list-style-type: none"> <li>- Please see classic soldering iron</li> </ul>	<p>✓</p> <p><u>Configurations</u></p> <ul style="list-style-type: none"> <li>- 150W soldering iron</li> <li>- 1 or 2 soldering heads</li> <li>- 3 or 4 axes</li> <li>- Work area: 500x500 or 300x300mm</li> </ul> <p><u>Options</u></p> <ul style="list-style-type: none"> <li>- Please classic soldering iron</li> </ul>	<p>✗</p> <p><u>Configuration not available</u></p>	<p>✓</p> <p><u>Configurations</u></p> <ul style="list-style-type: none"> <li>- 150W soldering iron</li> <li>- 3 or 4 axes</li> <li>- Work area: 300x300mm</li> </ul> <p><u>Options</u></p> <ul style="list-style-type: none"> <li>- Please see classic soldering iron</li> </ul>	<p>✓</p> <p><u>Configurations</u></p> <ul style="list-style-type: none"> <li>- 150W soldering iron</li> <li>- 3 or 4 axes</li> <li>- With or without soldering iron</li> <li>- Work area: 300x300mm or 500x500mm</li> </ul> <p><u>Options</u></p> <p>Please see common options below</p>	<p>✓</p> <p><u>Configurations</u></p> <ul style="list-style-type: none"> <li>- 150W soldering iron</li> <li>- Work area: according to the customer's needs</li> </ul> <p><u>Options</u></p> <ul style="list-style-type: none"> <li>- Additional pneumatic axes</li> </ul>
	 <p><b>PowerLas laser</b></p> <p><u>Options</u></p> <ul style="list-style-type: none"> <li>- Automatic laser recentering</li> <li>- Integrated pyrometer</li> <li>- Nitrogen generator</li> <li>- Set up for easy, normal and difficult products</li> </ul>	<p>✗</p> <p><u>Configuration not available</u></p>	<p>✓</p> <p><u>Configurations</u></p> <ul style="list-style-type: none"> <li>- 66W</li> <li>- Work area: 500x500mm</li> </ul> <p><u>Options</u></p> <ul style="list-style-type: none"> <li>- Opening system for lateral doors</li> <li>- Integration of a transfer system</li> <li>- SMEMA interface and conveyor</li> </ul>	<p>✓</p> <p><u>Configurations</u></p> <ul style="list-style-type: none"> <li>- 66W laser</li> <li>- Adapted platform for laser</li> <li>- Work area: 300x300mm</li> </ul> <p><u>Options</u></p> <p>Please see common options</p>	<p>✗</p> <p><u>Available configuration only upon request of a specific quotation</u></p>	<p>✗</p> <p><u>Available configuration only upon request of a specific quotation</u></p>
	 <p><b>Induction</b></p> <p><u>Options</u></p> <ul style="list-style-type: none"> <li>- Chiller</li> <li>- Controller for automatic power change</li> <li>- Nitrogen generator</li> <li>- 45kVAR instead of 32 kVAR</li> <li>- 63kVAR instead of 32 kVAR</li> <li>- Set up for easy, normal and difficult products</li> </ul>	<p>✓</p> <p><u>Configurations</u></p> <ul style="list-style-type: none"> <li>- 3 or 4 axes</li> <li>- Work area: 500x500 or 300x300mm</li> </ul> <p><u>Options</u></p> <ul style="list-style-type: none"> <li>- Integration of a transfer system</li> <li>- SMEMA interface and conveyor</li> <li>- LED illumination set</li> </ul>	<p>✗</p> <p><u>Configuration not available</u></p>	<p>✓</p> <p><u>Configurations</u></p> <ul style="list-style-type: none"> <li>- 3 or 4 axes</li> <li>- Work area 300x300mm</li> </ul> <p><u>Options</u></p> <ul style="list-style-type: none"> <li>- Back loading and/or unloading</li> <li>- Adjustable working height</li> <li>- Double-slide</li> </ul>	<p>✓</p> <p><u>Configurations</u></p> <ul style="list-style-type: none"> <li>- 3 or 4 axes</li> <li>- With or without induction head</li> <li>- Work area: 300x300mm or 500x500mm</li> </ul> <p><u>Options</u></p> <p>Please see common options</p>	<p>✓</p> <p><u>Configurations</u></p> <ul style="list-style-type: none"> <li>- Work area: according to the customer's needs</li> </ul> <p><u>Options</u></p> <ul style="list-style-type: none"> <li>- Additional pneumatic axes</li> </ul>
	 <p><b>Microflame</b></p> <p><u>Options</u></p> <ul style="list-style-type: none"> <li>- Flame presence control</li> <li>- Set up for easy, normal and difficult products</li> </ul>	<p>✓</p> <p><u>Configurations</u></p> <ul style="list-style-type: none"> <li>- 3 or 4 axes</li> <li>- Work area: 500x500 or 300x300mm</li> </ul> <p><u>Options</u></p> <ul style="list-style-type: none"> <li>- Integration of a transfer system</li> <li>- SMEMA interface and conveyor</li> <li>- LED illumination set</li> </ul>	<p>✗</p> <p><u>Configuration not available</u></p>	<p>✓</p> <p><u>Configurations</u></p> <ul style="list-style-type: none"> <li>- 3 or 4 axes</li> <li>- Work area 300x300mm</li> </ul> <p><u>Options</u></p> <ul style="list-style-type: none"> <li>- Back loading and/or unloading</li> <li>- Adjustable working height</li> <li>- Double-slide</li> </ul>	<p>✓</p> <p><u>Configurations</u></p> <ul style="list-style-type: none"> <li>- 3 or 4 axes</li> <li>- With or without microflame head</li> <li>- Work area: 300x300mm or 500x500mm</li> </ul> <p><u>Options</u></p> <p>Please see common options</p>	<p>✓</p> <p><u>Configurations</u></p> <ul style="list-style-type: none"> <li>- Work area: according to the customer's needs</li> </ul> <p><u>Options</u></p> <ul style="list-style-type: none"> <li>- Additional pneumatic axes</li> </ul>
		<p><b>Common options:</b> remote support "team viewer", monitoring black and white or color, presence probe of parts, ESD protection kit, vision system for quality inspection,</p>			<p>detection of parts, fluxing system, PowerClean fume exhaust system, height measuring vision system for recentering and customer specific fixture.</p>	



## Platform controllers

### Robotic cell and table-top robot

The mta® standard platforms, such as the MRC500 robotic cell and the TR300 table-top robot, are controlled using an industrial PC, running a WINDOWS operating system.

The PC and all the hardware needed to control the robot and the processes are integrated and delivered within the standard platforms. State-of-the-art connection and interfaces are already integrated in order to communicate with other systems, controllers, etc.

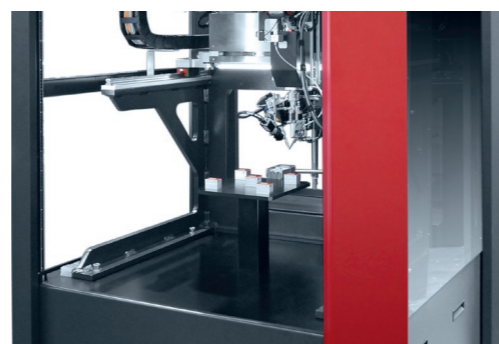

### OEM and station for integrator

#### Software/controller configurator

Techniques	Motion Editor	Station Configurator	Controller type
Classic Iron soldering + wire feeder		✓	19" rack
Classic Iron soldering + wire feeder + 1 Z axis (pneumatic or numerical)	✓	✓	19" rack
MSH150 iron soldering standalone			embedded
Microflame + wire feeder	✓		19" rack
Microflame + wire feeder + 1 Z axis (pneumatic or numerical)	✓		19" rack
Induction + wire feeder	✓		19" rack
Induction + wire feeder + 1 Z axis (pneumatic or numerical)	✓		19" rack
PowerLas laser soldering	✓		19" rack

### Electrical controllers

An Embedded solution is proposed and consists of a completely autonomous electrical controller in the shape of a 19" rack, which requires a 230V power supply.

With the 19" rack, a process with up to two optional numerical axes can be managed.



## mta® software

With more than 20 years of experience in the design/creation of software dedicated to soldering processes, the mta® solutions offered by Unitechnologies propose a large range of possibilities to accelerate the integration of the controllers. The software is permanently evolving and covers the entirety of the needs spotted in the mta® laboratories and by the customers.

Two software applications are available to enable the operator to interact with the mta® controller electronics. The mta® proprietary software applications MotionEditor and Station Configurator offer a large number of functions simplifying the use of the available processes. These software applications can be integrated into all platforms of the mta® product range.

With the mta® MotionEditor software, the operator can access the different parameters and execute cycles from a single window. Its modular basis accommodates all mta® processes. Furthermore, its .Net C# programming opens the door to the integration of new functions according to the customer's specific needs. It consists of a main window which indicates the current status and of a "sequence" window from which the operator can add or remove actions in a cycle. The operator is in charge of the order of execution of the various operations and of the general behavior of the system.

Stations with a simpler process can easily be managed by a PLC to execute an action. In this system, the mta® electrical controllers are integrated by the customer and are managed as slaves via an I/O communication protocol. The mta® Station Configurator software is used to edit the parameters of the PLC via a serial communication. The station only requires a connection to a laptop through which a qualified operator can enter the parameters so that the stations can then work autonomously. An industrial PC dedicated to this task can be offered as an option.

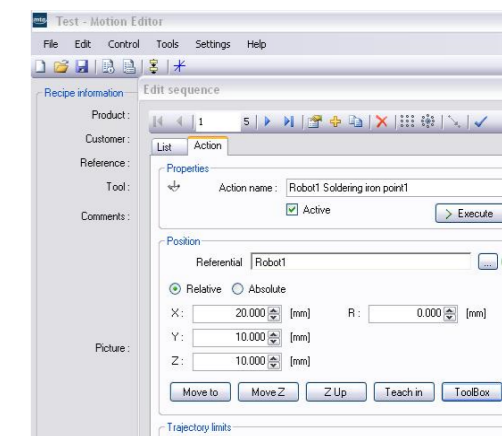

## Software comparison

	MotionEditor	Station Configurator
<b>Environment</b>	Windows	Windows / PLC
<b>HMI</b>	full graphic interface	parameter editor
<b>Interface with mta® station</b>	CAN or serial (RS232)	PLC integrated to the station
<b>Interface with the customer</b>	digital I/O, RS232, Ethernet	digital I/O
<b>System</b>	full control via a sequence editor	process parameter setting for one point
<b>Receipt</b>	unlimited receipt number	16 receipts of a programmable point
<b>Specificity</b>	adjustable I/O and numerical axis number	runs in cycle without PC
<b>Extension possibility</b>	additional functionalities as needed	none

## Providing turnkey solutions

With over 50 years of experience in automation, Unitechnologies can propose the best possible solution available for the realization of turnkey systems for all automation processes peripheral to the soldering and dispensing operations.

The highly qualified staff, state-of-the-art infrastructure and proven methods of managing knowledge and mastering risks are key factors to innovative solutions perfectly adapted to the customer's needs.

Unitechnologies' workforce faces daily challenges in mastering multidisciplinary projects. The open minded corporate culture facilitates the integration of external competences into company internal skills, resulting in a high level of success for all partners involved in an automation project.



## Assembly line example

### Product

Pressure sensor for the medical industry.

### Operations

- Assembly of wires and moulding.
- Dispensing of solder paste.
- Soldering of wires on a ceramic substrate.



## Key competences

### Integration of assembly processes

- Specific attachments processes such as laser, welding, gluing or crimping
- High precision, shock-free numerical positioning
- Handling of delicate or elastic components

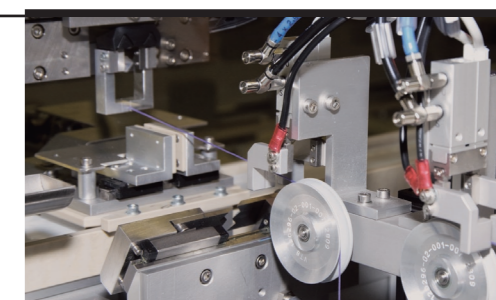

### Integration of on-line measuring systems

- Multicamera vision systems
- Analogical physical signals
- Force measurement systems



### High performance project management

- Realization of customized machines
- Multidisciplinary coordination with several partners
- Machine validation according to DQ, IQ and OQ procedures



### Expertise in the architecture of automated systems

- Methodological approach including product design analysis
- Extensive expertise of microtechnical technologies
- Mastering of extreme flexibility constraints

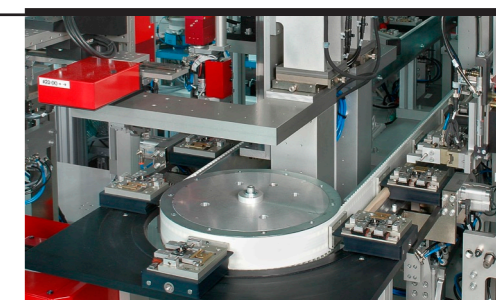

### Mastery of numerical technologies and robotics

- High precision robotics
- Integration of multi-axis robots from the market
- Automation of tools according to specific requirements

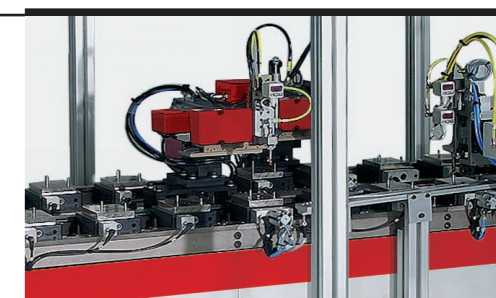

## Solder consumables

In order to guarantee a long machine life span and to avoid difficulties in acquiring spare parts, a large selection of mta® consumables and spare parts is available from the Unitechnologies' customer service team.

The consumables are limited to four main types: iron soldering tips, heating units, wire feeder guides and cleaning sponges. Each type is described below:

### Solder tips

The design of the mta® solder tips is the result of 50 years of experience in the soldering domain. This unique design is based on the following key parameters:

- Easy changeover of the tip: it can be changed within a few seconds and a minimum of steps. The simple and accurate spring lock ensures the replacement of the tips without requiring any further changes to the machine.
- Long life span: the design ensures a long life span of the tips up to 80'000 soldering points depending on the application.
- Accurate temperature control and thermal transfer: the main challenge in an iron soldering device is the quality of the thermal transfer between the heating element and the tip. In addition, the measurement and the control of the temperature must be fast and accurate.

A large range of standard tips for 80W and 150W soldering heads, corresponding to the most common uses, is available. Specific tips can also be offered depending on the customer's application. mta® tips can be used for both lead and lead free soldering.

### Wire feeder platforms

As a key element of the soldering robot, the wire feeder drives the solder alloy to the exact position required by the application. This unit is adaptable to several wire diameters. At the end of the device, the wire is guided through a tube, which, due to the continuous pollution of the soldering alloy, must be replaced from time to time.

### Solder wires

The solder wire plays a significant role in the success of the process. Two product ranges are available: own mta® solder wires and distributor solder wires.

### Heating units

Heating elements are available for both 80W and 150W irons. As these units are submitted to high temperature, they need to be replaced from time to time and as such can easily be changed when necessary.

### Cleaning sponges

mta® brand has a proprietary design for the tip cleaning units which consist of two rotating sponges with manual or automatic wetting system. These sponges have to be replaced from time to time.

### Examples of consumables

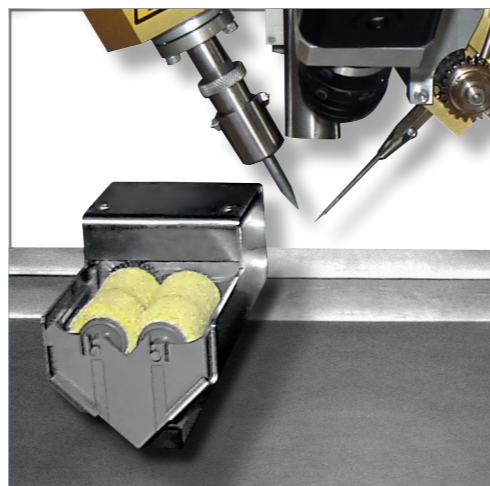
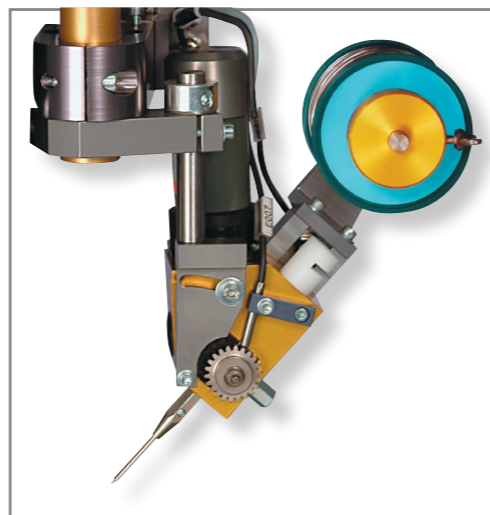

## Solder tips

### List of 80W solder tips

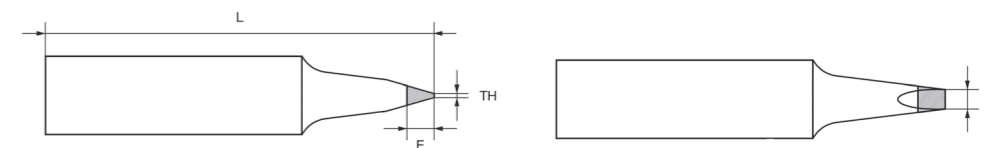

Article number	L	E	W	TH	Illustration
5-0005-99-015-00	50 mm	1.5 mm	1.5 mm	0.5 mm	
5-0005-99-016-00	50 mm	3.5 mm	2.5 mm	0.5 mm	
5-0005-99-017-00	50 mm	2.5 mm	3 mm	0.5 mm	
5-0005-99-020-00	50 mm	4.5 mm	5 mm	1 mm	
5-0005-99-021-00	50 mm	1.5 mm	2 mm	0.5 mm	
5-0005-99-022-00	50 mm	1.5 mm	0.8 mm	0.5 mm	
5-0005-99-023-00	50 mm	3 mm	3 mm	25°	
5-0005-99-026-00	50 mm	1.5 mm	1.5 mm	0.5 mm	
5-0005-99-027-00	53 mm	4.5 mm	5.5 mm	1mm x 45°	
5-0005-99-028-00	50 mm	2 mm	2.5 mm	0.5 mm	
5-0005-99-030-00	50 mm	2 mm	4 mm	0.5 mm	
5-0005-99-031-00	50 mm	4 mm	3 mm	0.5 mm	
5-0005-99-032-00	50 mm	1.5 mm	1.7 mm	0.5 mm	
5-0005-99-033-00	50 mm	2 mm	4 mm	0.5 mm	
5-0005-99-034-00	50 mm	1.5 mm	2 mm	0.5 mm	
5-0005-99-035-00	50 mm	3.5 mm	2.5 mm	0.5 mm	
5-0005-99-036-00	50 mm	1.5 mm	3 mm	0.5 mm	
5-0005-99-037-00	50 mm	2 mm	4 mm	0.5 mm	
5-0005-99-038-00	50 mm	4-5mm	5 mm	1mm x 45°	
5-0005-99-039-00	50 mm	1.5 mm	1.2 mm	0.5 mm	
5-0005-99-040-00	50 mm	1.5 mm	2 mm	R0.8 mm	

## Solder tips

List of 80W solder tips - continuation

Article number	L	E	W	TH	Illustration
5-0005-99-041-00	50 mm	3 mm	3 mm	0.5 mm	
5-0005-99-042-00	50 mm	7 mm	1.5 mm	0.5 mm	
5-0005-99-048-00	50 mm	1 mm	1 mm	R0.2 mm	
5-0005-99-049-00	50 mm	6 mm	5 mm	1mm x 45°	
5-0005-99-050-00	50 mm	9 mm	2 mm	0.5 mm	
5-0005-99-051-00	50 mm	2.5 mm	1.5 mm	0.5 mm	
5-0005-99-053-00	50 mm	1.5 mm	0.8 mm	0.5 mm	
5-0005-99-054-00	50 mm	1.5 mm	2 mm	0.5 mm	
5-0005-99-055-00	62 mm	1.5 mm	2 mm	0.5 mm	
5-0005-99-060-00	50 mm	15 mm	3 mm	0.5 mm	
5-0005-99-078-00	50 mm	6 mm	3 mm	1mm x 45°	
5-0005-99-088-00	50 mm	2 mm	2.8 mm	2.5mm x 25°	
5-0005-99-089-00	50 mm	4.5 mm	2.5 mm	0.5 mm	
5-0005-99-090-00	50 mm	1.5 mm	1 mm	0.5 mm	
5-0005-99-091-00	50 mm	1 mm	1.5 mm	1.4 x 25°	
5-0005-99-092-00	50 mm	2 mm	2mmx30°	0.5 mm	
5-0005-99-093-00	50 mm	3.5 mm	3.5 mm	90°	
5-0005-99-094-00	50 mm	1.5 mm	1.5 mm	0.55 mm	
5-0005-99-095-00	50 mm	1.5 mm	1.2 mm	0.5 mm	
5-0005-99-096-00	50 mm	6 mm	7 mm	1mm x 45°	
5-0005-99-097-00	50 mm	2 mm	4 mm	0.5 mm	
5-0005-99-099-00	50 mm	1.5 mm	2 mm	0.5 mm	

## Solder tips

List of 80W solder tips - continuation

Article number	L	E	W	TH	Illustration
5-0005-99-115-00	50 mm	9 mm	2.5 mm	0.5 mm	
5-0005-99-213-00	50 mm	1.5 mm	2 mm	5 mm	
5-0005-99-214-00	50 mm	3 mm	2 mm	0.5 mm	
5-0005-99-216-00	50 mm	6 mm	3.5 mm	1mm x 45°	
5-0005-99-217-00	53 mm	4-5mm	4.5 mm	1mm x 45°	
5-0005-99-219-00	50 mm	2 mm	4 mm	0.5 mm	
5-0005-99-220-00	50 mm	3 mm	2 mm	0.5 mm	
5-0005-99-221-00	50 mm	1.5 mm	1.6 mm	0.5 mm	
5-0005-99-222-00	50 mm	6 mm	3.5 mm	1mm x 22°	
5-0005-99-224-00	50 mm	4.5 mm	5.5 mm	special	
5-0005-99-225-00	50 mm	1.5 mm	2 mm	special	
5-0005-99-227-00	53 mm	4.5 mm	3.5 mm	0.5 mm	
5-0005-99-228-00	50 mm	3 mm	8 mm	1 x 45°	
5-0005-99-229-00	50 mm	6 mm	10 mm	0.7mm x 35°	
5-0005-99-231-00	50 mm	6 mm	8 mm	0.7mm x 35°	
5-0005-99-232-00	50 mm	6 mm	6.7 mm	0.7mm x 35°	
5-0005-99-516-00	50 mm	2 mm	2.5 mm	0.5 mm	
5-0005-99-517-00	50 mm	1.5 mm	3 mm	0.5 mm	
5-0005-99-521-00	50 mm	1.5 mm	2 mm	0.5 mm	
5-0005-99-526-00	50 mm	1.5 mm	1.5 mm	0.5 mm	
5-0005-99-527-00	53 mm	4-5mm	5.5 mm	1mm x 45°	
5-0005-99-528-00	50 mm	3 mm	2.6 mm	0.5 mm	

## Solder tips

List of 150W solder tips

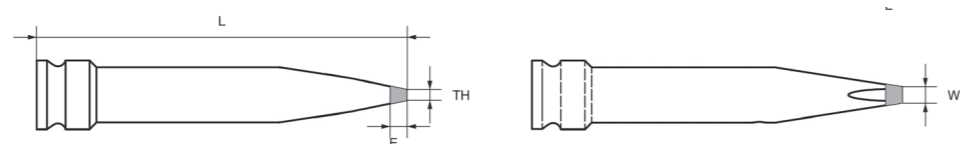

Article number	L	E	W	TH	Illustration
5-0005-99-611-30	35 mm	2 mm	2.5 mm	1mm x 25°	
5-0005-99-612-20	35 mm	2 mm	2.5 mm	0.5 mm	
5-0005-99-613-20	35 mm	1.5 mm	1.5 mm	1 mm	
5-0005-99-614-20	35 mm	1.5 mm	2 mm	1 mm	
5-0005-99-615-20	35 mm	1.5 mm	2 mm	1 mm	
5-0005-99-616-20	35 mm	1.5 mm	2 mm	0.5 mm	
5-0005-99-617-20	35 mm	2 mm	3 mm	1 mm	
5-0005-99-617-30	35 mm	2 mm	3 mm	1mm x 25°	
5-0005-99-618-20	35 mm	2 mm	3 mm	0.5 mm	
5-0005-99-619-20	35 mm	2 mm	4 mm	1 mm	
5-0005-99-619-30	35 mm	2 mm	4 mm	1mm x 25°	
5-0005-99-620-00	35 mm	2 mm	4 mm	0.5 mm	
5-0005-99-622-10	35 mm	1.5 mm	1 mm	0.5 mm	
5-0005-99-624-20	35 mm	2 mm	3 mm	0.5 mm	
5-0005-99-627-20	35 mm	4.5 mm	4 mm	0.5 mm	
5-0005-99-628-20	35 mm	2 mm	2.5 mm	0.5 mm	
5-0005-99-630-20	35 mm	1.5 mm	0.8 mm	0.5 mm	
5-0005-99-631-20	35 mm	2 mm	2.5 mm	0.5 mm	
5-0005-99-632-20	35 mm	2 mm	2.5 mm	0.5 mm	
5-0005-99-633-20	35 mm	1.5 mm	2 mm	0.5 mm	

## Solder tips

List of 150W solder tips - continuation

Article number	L	E	W	TH	Illustration
5-0005-99-634-20	35 mm	2 mm	3 mm	0.5 mm	
5-0005-99-636-20	35 mm	1.5 mm	1 mm	0.5 mm	
5-0005-99-638-20	35 mm	2 mm	3 mm	0.5 mm	
5-0005-99-641-20	35 mm	1.5 mm	0.8 mm	0.5 mm	
5-0005-99-642-20	35 mm	4 mm	6.5 mm	0.5mm x 35°	
5-0005-99-643-20	35 mm	4 mm	6.5 mm	0.7mm x 35°	
5-0005-99-646-20	35 mm	5 mm	10 mm	0.5mm x 35°	
5-0005-99-648-20	35 mm	3 mm	5.2 mm	0.5mm x 35°	
5-0005-99-649-20	35 mm	4 mm	5.2 mm	0.7mm x 35°	
5-0005-99-650-20	35 mm	2.5 mm	3 mm	0.7mm x 35°	
5-0005-99-650-30	35 mm	2.5 mm	3 mm	0.82mm x 25°	
5-0005-99-651-20	35 mm	3 mm	4 mm	0.7mm x 35°	
5-0005-99-652-20	35 mm	2 mm	2.2 mm	0.6mm x 35°	
5-0005-99-652-30	35 mm	2 mm	2.2 mm	0.7mm x 25°	
5-0005-99-655-20	35 mm	2 mm	2.5 mm	0.5 mm	
5-0005-99-656-20	35 mm	4 mm	2.5 mm	0.5 mm	
5-0005-99-658-20	35 mm	0.7 mm	1.2 mm	0.7mm x 25° (hole 0.30mm)	
5-0005-99-658-30	35 mm	0.7 mm	1.2 mm	0.7mm x 25° (hole 0.32mm)	
5-0005-99-668-30	35 mm	0.7 mm	1.2 mm	0.22mm x 45° & 0.3mm x 45°	
5-0005-99-670-30	35 mm	2 mm	2.2 mm	0.7mm x 25°	
5-0005-99-672-20	35 mm	2 mm	1.5 mm	0.5mm x 20°	

## Own mta® solder wires

mta® solder wires are based on moderately activated synthetic resin for professional electronics use. It is recommended for use on gold, HAL or chemical tin surface finishes. This alloy has been developed to achieve the lowest possible dissolution rate of copper and iron. Depending on the general conditions, an increase in the life time of solder tips of up to 50% is possible.

All material complies with the Directive 2011/65/EU (RoHS).



### Sn96Ag3Cu1 (SAC 305) - high efficiency alloy

The alloy used here is close to the eutectic composed of tin, silver and copper. Typical application: due to the added silver, it can be used more particularly in cases where an improvement of wettability is required.

#### Specifications

Components	%	*OEL (mg/m3)	*CAS n°	*EINECS n°	Classification	Melting point
Tin	96.0	2 ACGIH-TWA	7440-31-5	231-141-8	not classified	217.5°-220°
Silver	3.0	0.1 directive   2000/39/CE	7439-92-1	231-100-4	not classified, limited use	
Copper	1.0	1 dusts and mists   0.2 as fumes ACGIH TWA	7440-5-8	231-159-6	not classified	

#### References

Article number	Diameter mm	Weight kg
5-0005-97-003-05	0.5	0.500
5-0005-97-003-08	0.8	
5-0005-97-003-10	1.0	

### Sn99Cu1 - cost effective alloy

This alloy is a eutectic alloy of tin and copper. Typical application: frequently used for and accepted by the majority of soldering applications with iron head.

#### Specifications

Components	%	*OEL (mg/m3)	*CAS n°	*EINECS n°	Classification	Melting point
Tin	99.3	2 ACGIH-TWA	7440-31-5	231-141-8	not classified	227°
Copper	0.7	1 dusts and mists   0.2 as fumes ACGIH TWA	7440-5-8	231-159-6	not classified	227°

#### References

Article number	Diameter mm	Weight kg
5-0005-97-004-05	0.5	0.500
5-0005-97-004-08	0.8	
5-0005-97-004-10	1.0	

## Flux

Halide activated, colophony-free flux based on a synthetic resin matrix according to the following norm: - ANS J-STD-004 / class REL1. Flux of 3.5% ± 0.3%. The residue is non-corrosive and is of the type NO CLEAN. It can be removed by cleaning with alcohol.

\*Legend: OEL=Occupational exposure limit CAS=Product registration number EINECS European Inventory of Existing Commercial Chemical Substances

## Distributor solder wires

Choosing the right solder wire is critical to the success of the process. Unitechnologies is the right partner to assist its customers through this step.

Thanks to dealership agreements with major solder wire suppliers, Unitechnologies not only provides its customers with the best technical support but also offers a wide range of products at a very competitive price.

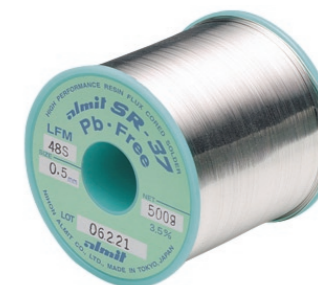

## Other solder consumables

### Heating units

Article number	Description
5-0005-03-215-10	Heating unit 80W
5-0084-01-122-00	Heating unit 150W

### Cleaning units

Article number	Description
5-0004-02-000-23	Complete iron cleaning unit NF02
5-0004-02-012-21	Tin receiver with rollers
7-0238-00-000-00	Bag of 24 sponges





mta

SOLDERING & DISPENSING

# THE ART OF PRECISION

---

## Headquarters

### **Unitechnologies SA**

Bernstrasse 5  
CH-3238 Gals  
Switzerland

T +41 32 338 80 80  
F +41 32 338 80 99  
info@unitechnologies.com  
www.unitechnologies.com

## Subsidiary USA

### **mta automation inc.**

50-1 River Street  
US-Old Saybrook, CT 06475  
USA

T +1 860 399 1141  
F +1 860 399 1159  
info@mtaautomation.com  
www.mtaautomation.com



unitechnologies

THE ART OF PRECISION